

# FM 23-30

WAR DEPARTMENT BASIC FIELD MANUAL

*L.T. L.T. Ferguson, O-1118037*

## HAND AND RIFLE GRENADES

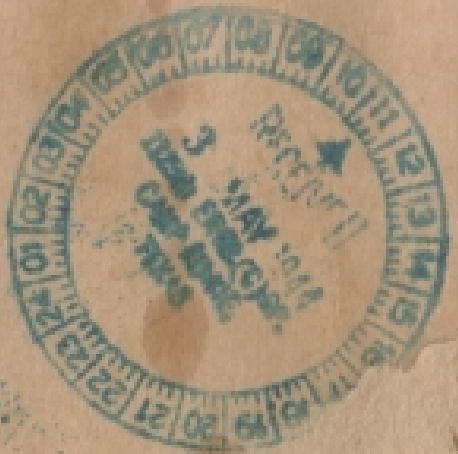
### ROCKET, AT, HE,

### 2.36-INCH

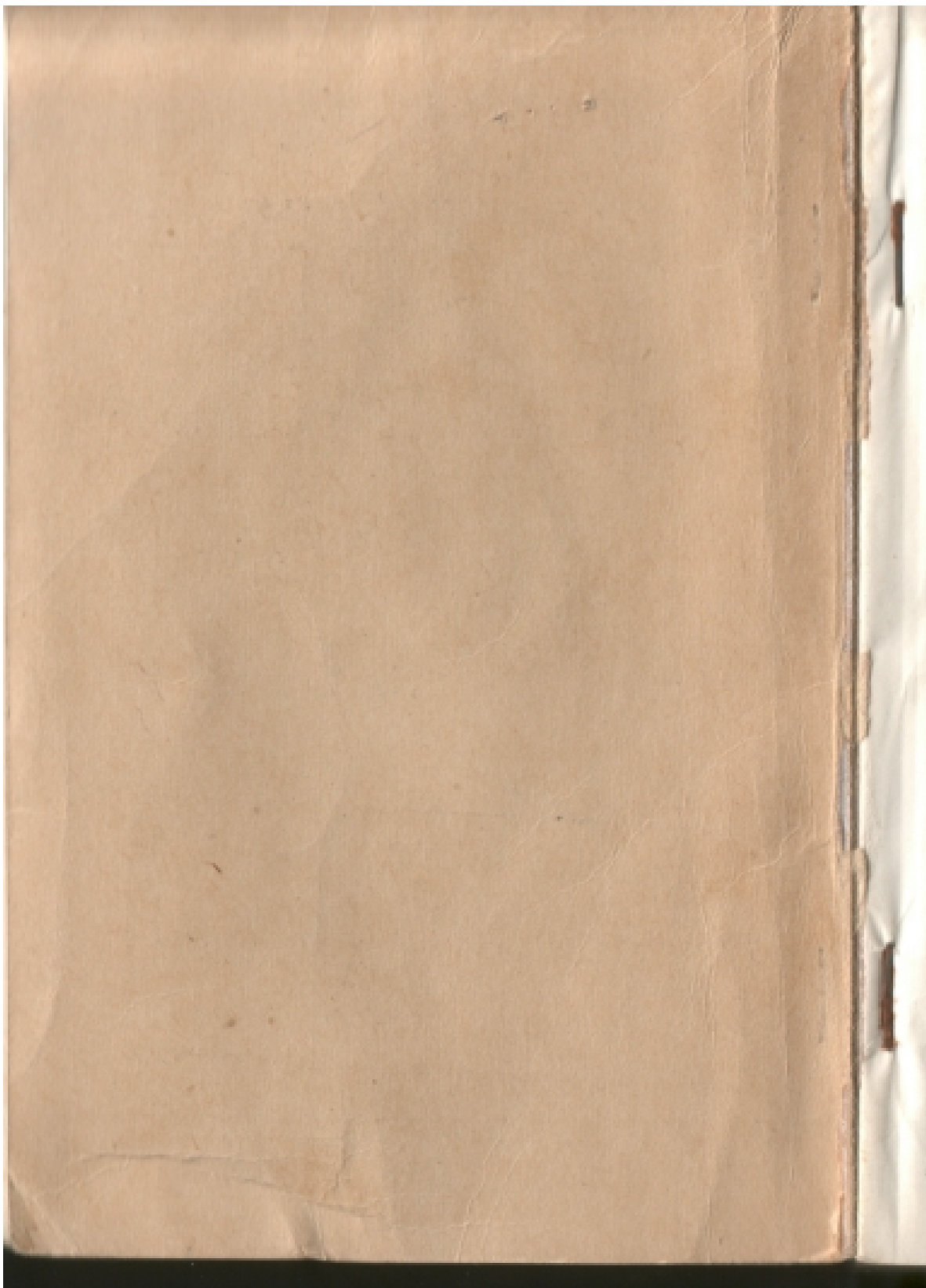
**RESTRICTED.** DISSEMINATION OF RESTRICTED MATTER.—  
The information contained in restricted documents and the essential characteristics of restricted material may be given to any person known to be in the service of the United States and to persons of undoubted loyalty and discretion who are co-operating in Government work, but will not be communicated to the public or to the press except by authorized military public relations agencies. (See also par. 13b, AR 380-5, 28 Sep. 1942.)

WAR DEPARTMENT • 14 FEBRUARY 1944

FM23-30 Hand + Rifle Grenades, Rocket, AT, HE, 2.75 inch







WAR DEPARTMENT BASIC FIELD MANUAL

FM 23-30

*This manual supersedes FM 23-30, 15 June 1942, including C 1, 4 September 1942, C 2, 10 October 1942, C 3, 17 October 1942, C 4, 19 January 1943, C 5, 11 March 1943, C 6, 20 May 1943, C 7, 26 August 1943; Training Circular No. 104, War Department, 1942; Training Circulars Nos. 10, 46, 77, 80, 82, 92, and 120, War Department, 1943.*

---

HAND AND RIFLE  
GRENADES

ROCKET, AT, HE,  
2.36-INCH



WAR DEPARTMENT : 14 FEBRUARY 1944

---

**RESTRICTED. DISSEMINATION OF RESTRICTED MATTER.**

—The information contained in restricted documents and the essential characteristics of restricted material may be given to any person known to be in the service of the United States and to persons of undoubted loyalty and discretion who are cooperating in Government work, but will not be communicated to the public or to the press except by authorized military public relations agencies. (See also par. 186, AR 380-5, 28 September 1942.)

---

United States Government Printing Office  
Washington : 1944

# CONTENTS

## CHAPTER 1. HAND GRENADES

	<i>Paragraphs</i>	<i>Page</i>
<i>Section</i> I. General . . . . .	1-4	1
II. Training and practice . . . . .	5-11	17
III. Combat training . . . . .	12-16	35
IV. Safety precautions, police of range, and destruction of duds . . . . .	17-24	42
V. Advice to instructors . . . . .	25-28	50

## CHAPTER 2. RIFLE GRENADES

<i>Section</i> I. Grenades, accessories, sequence of operations, and mechan- ical training . . . . .	29-34	55
II. Antitank marksmanship . . . . .	35-46	75
III. Antipersonnel marksmanship . . . . .	47-56	93
IV. Safety precautions . . . . .	57-58	115
V. Advice to instructors . . . . .	59-61	117

## CHAPTER 3. ROCKET, AT, 2.36-INCH, AND LAUNCHER

<i>Section</i> I. General . . . . .	62-63	120
II. Characteristics and description of antitank rocket launchers M1A1 and M9 . . . . .	64-67	122

III. Ammunition .....	68-72	134
IV. Maintenance .....	73-79	143
V. Operation .....	80-83	153
VI. Marksmanship .....	84-88	161
VII. Tactical employment .....	89-92	180
VIII. General information .....	93-95	185
<b>CHAPTER 4. SPECIAL INSTRUCTIONS</b> .....	96	189
<b>APPENDIX. LIST OF REFERENCES</b> .....		191
<b>INDEX</b> .....		192

WAR DEPARTMENT,  
Washington 25, D. C., 14 February 1944.

FM 23-30, Hand and Rifle Grenades; Rocket, AT, HE, 2.36-inch, is published for the information and guidance of all concerned.

[A.G. 300.7 (22 Dec 43).]

BY ORDER OF THE SECRETARY OF WAR:

G. C. MARSHALL,  
*Chief of Staff.*

OFFICIAL:

J. A. ULIO,  
*Major General,*  
*The Adjutant General.*

DISTRIBUTION:

Bn & H 1-7, 9-11, 17-19, 44 (5); IC 2, 6, 7, 17,  
18 (20), 3-5, 9, 11, 19, 44 (10); C 18 (3).

(For explanation of symbols see FM 21-6.)

*(This manual supersedes FM 21-30, 13 June 1942, including C 1, 4 September 1942; C 2, 10 October 1942; C 3, 17 October 1942; C 4, 19 January 1943; C 5, 21 March 1943; C 6, 20 May 1943; C 7, 26 August 1943; Training Circular No. 102, War Department, 1942; Training Circulars Nos. 10, 46, 77, 80, 82, 93, and 120, War Department, 1943.)*

*Attention is directed to FM 21-7, "List of Training Films, Film Strips, and Film Bulletins," for details as to how appropriate training films and film strips are intended to be used, and how they are made available for training in the use of hand and rifle grenades and the rocket, AT, HE, 2 1/2-inch.*

## CHAPTER 1 HAND GRENADES

---

### SECTION I GENERAL

**1. TYPES.** Hand grenades are divided into the following types:

**a.** Fragmentation grenades, containing an explosive charge in a body designed to fragment with the action of the bursting charge.

**b.** Offensive grenades, containing a high explosive charge in a paper body, designed for demolition effect.

**c.** Chemical grenades, containing a chemical agent which produces a toxic or irritant physiological effect, a screening or signal smoke, an incendiary action, or any combination of these.

**d.** Practice grenades, containing a reduced charge, to simulate fragmentation grenades.

**e.** Training grenades, containing no explosive or chemical.

**2. FILLERS.** The filler is the substance contained in the body of a grenade. Fillers used are —

**a. EC (explosive company) blank fire smokeless powder.** This is a commercial type granulated nitrocellulose powder, generally pink or yellow in color. It is less powerful than TNT and is exploded by ignition rather than detonation. Grenades loaded with this material can be issued fuzed and ready for use and are, in general, not susceptible to mass detonation.

**b. Trinitrotoluene (TNT).** TNT is stable but, unlike blank fire powder, it explodes by detonation. TNT in block form is used for demolitions.

**c. Chloracetophenone (CN).** This is a lachrymatory (tear) gas which produces a severe burning sensation in the eyes, causing intense weeping. In one type of irritant hand grenade, CN is combined with diphenylaminechlorarsine (**d** below).

**d. Diphenylaminechlorarsine (DM).** DM is a gas which causes a burning sensation in the nose and throat and a heavy or tight feeling in the chest. There is also a nauseating effect, the degree of which depends on the concentration of the gas and the length of exposure.

**e. Hexachlorethane-zinc mixture (HC).** Upon ignition, HC mixture produces a dense white smoke which is harmless. HC smoke grenades are used by the Army Air Forces and the Armored Command for signals.

**f. Sulphur trioxide-chlorosulfonic acid mixture (FS).** FS is a corrosive liquid which reacts with the atmosphere, producing an effective screening smoke.

**g. Hydrocyanic acid (AC).** AC is a clear colorless liquid which vaporizes to a clear colorless gas upon release from the container. It is a powerful nerve poison, nonpersistent, and has an odor of bitter almonds or crushed peaches. A weak concentration causes an unpleasant taste in the mouth, dizziness, headache, and a rush of blood to the head. In strong concentrations, death is instantaneous.

**h. Gasoline (thickened) (NP).** NP is a thickened incendiary material composed of a mixture of napalm and gasoline. It readily adheres to smooth surfaces and effectively ignites combustible materials.

**i. Gasoline (thickened) (IM).** IM is a thickened incendiary material which readily adheres to smooth surfaces. It effectively ignites combustible materials.

**j. Thermate (TH).** TH is an incendiary material composed of thermit and other ingredients which, upon igniting, develops a temperature of 5,000° F. Grenades filled with TH are used to melt together movable metal parts, and against materials which are difficult to ignite.

**k. White phosphorus (WP).** Upon ignition and contact with the air, white phosphorus burns to a white smoke. Grenades filled with WP are effective agents for screening small unit operations. White phosphorus is also an incendiary; the burning particles produce casualties and have a harassing effect on the enemy.

**l. Colored smoke.** This is a mixture of sulphur, potassium chlorate, sodium bicarbonate, and dye to produce the desired color. Grenades filled with colored smoke are used as signals for air-ground and ground-to-ground communication.

**3. COMPONENTS. a. Time Fuze.** (1) FOR DEMOLITIONS AND DESTRUCTION OF DUDS. The time fuze, or safety fuze, is a cord containing a slow-burning powder train. The time fuze issued to the service is known commercially as Bickford fuze and burns at the approximate rate of 15 inches per minute. Time fuze should always be tested before using to determine its rate of burning.

(2) FOR GRENADES. The time fuze in grenade firing mechanisms is cut to burn for varying lengths of time, depending upon the type of grenade. Two fuzes are used with fragmentation grenades: M10A2, cut to burn from



4.3 to 5.5 seconds; M10A3, cut to burn from 4.6 to 4.8 seconds. The M10A2 is commonly referred to as the 4½-second fuze; the M10A3 as the 4-second fuze. Fuzes used with chemical grenades are cut to burn for 2 seconds.

**b. Detonators.** A detonator is a metal capsule filled with a detonating explosive such as fulminate of mercury. Commercial detonators come in ten sizes, numbered 1 to 10. The higher numbered sizes are larger and contain increasing amounts of the denonating mixture. Nos. 6 and 8 are the ones used in grenades. Detonators are sensitive to heat, shock, and friction and should be handled carefully at all times.

**c. Fuzes.** The fuze is the mechanism that fires the grenade. Fuzes are described in detail and their functioning explained in TM 9-1985. All hand grenade fuzes are time and automatic. Time means that the grenade is fired after a certain lapse of time and not on percussion. Automatic means that the fuze begins to function automatically as it leaves the hand, providing the safety cotter pin has been removed, thus providing a safety factor by eliminating the necessity of starting the action of the mechanism before the grenade is on its way. As to the final action, fuzes may be classified, as detonating or igniting.

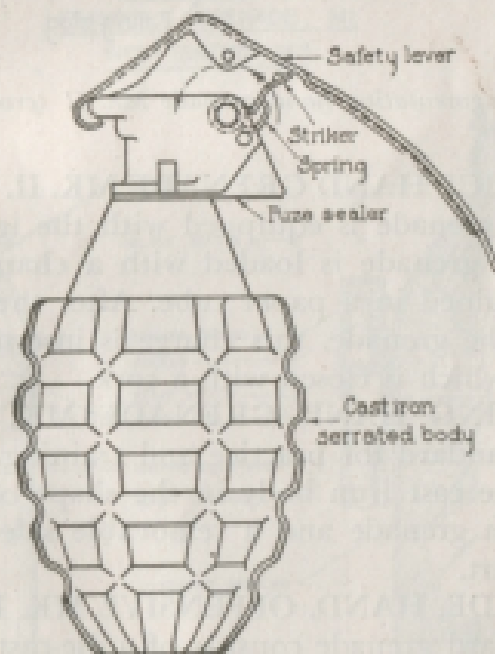
(1) **DETONATING FUZES.** Detonating fuzes contain a detonator. The function of the detonator is either to set off the explosive charge or to burst the container and liberate the filler.

(2) **IGNITING FUZES.** Igniting fuzes contain a small quantity of black powder or a powder pellet that ignites the filler as though a lighted match were applied.

(3) **IGNITER M3.** The igniter M3 is used with the frangible grenade M1 (see par. 4a (5)).

**4. CHARACTERISTICS.** a. The essential characteristics of hand grenades are as follows:

(1) **FRAGMENTATION HAND GRENADE MK. II** (figs. 1 and 2). The body of this grenade is made of cast iron and is about the size of a large lemon. The outside surface is deeply serrated horizontally and vertically to assist in forming uniform fragments when the grenade explodes. The bursting charge is 0.74 ounce of EC blank fire powder, and the grenade is fuzeed with either the M10A2 igniting fuze with a  $4\frac{1}{2}$ -second delay or the M10A3 igniting fuze with a 4-second delay. Fragments may fly over 200 yards.



*Figure 1. Fragmentation hand grenade Mk. II.*

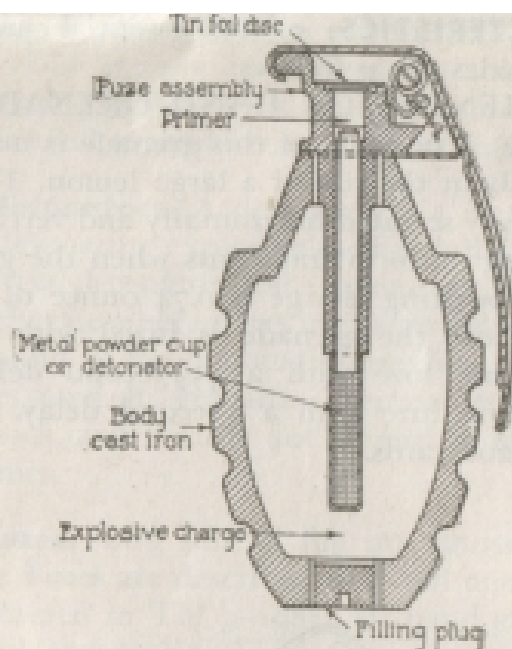


Figure 2. Fragmentation hand grenade Mk. II (cross section).

(2) **PRACTICE HAND GRENADE MK. II.** This standard practice grenade is equipped with the igniting fuze M10A1. The grenade is loaded with a charge of black powder contained in a paper tube. After the fuze is assembled in the grenade, this charge is inserted into the filling hole, which is closed with a cork.

(3) **TRAINING HAND GRENADE MK. 1A1.** This grenade is standard for practice and training. It consists of a one-piece cast iron body in the shape of the fuze fragmentation grenade and a removable safety pin and ring. It is inert.

(4) **GRENADE, HAND, OFFENSIVE MK. IIIA1.** This limited standard grenade consists of a die-cast top which is threaded to receive the fuze, detonating, hand grenade M6A2, and a body of laminated cartridge paper which contains the high-explosive charge. This grenade is for

demolition. It may be used in the open more safely than the fragmentation grenade because there is no marked fragmentation. Grenade bodies and fuzes are shipped separately.

(5) FRANGIBLE GRENADE M<sub>1</sub> (fig. 3). (a) This grenade is a common glass pint bottle equipped with a crimped metal cap and is used with the following chemical fillers: FS, AC, NP, and IM. No bursting charge is provided. Dispersal of contents is produced when the bottle is shattered by impact.

(b) When the frangible grenade M<sub>1</sub> is filled with incendiary filler NP or IM, it is equipped with the M<sub>3</sub> igniter (par. 3c (3)). This igniter consists of an igniter fuze

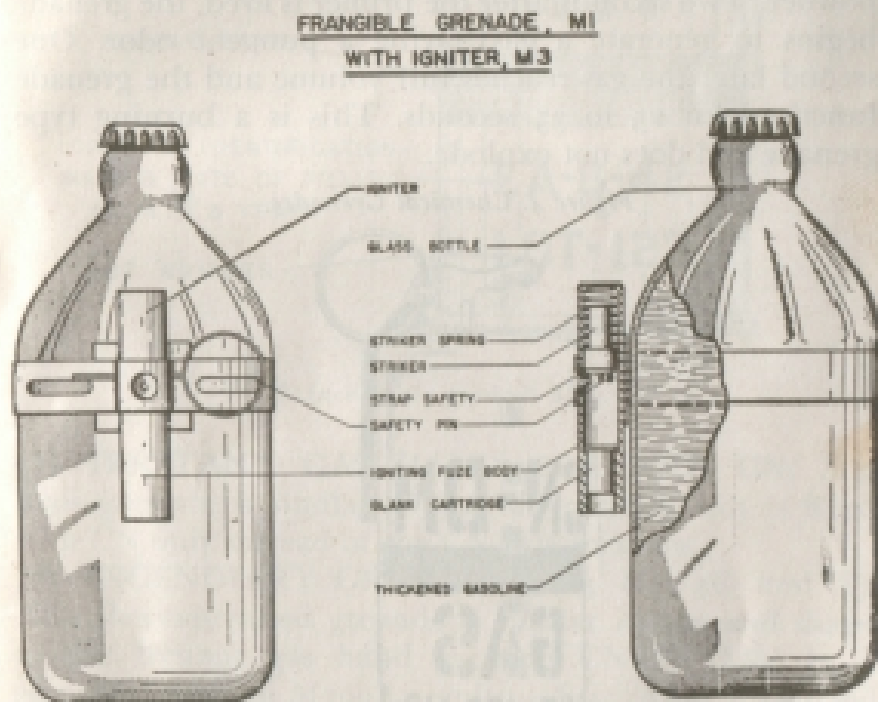
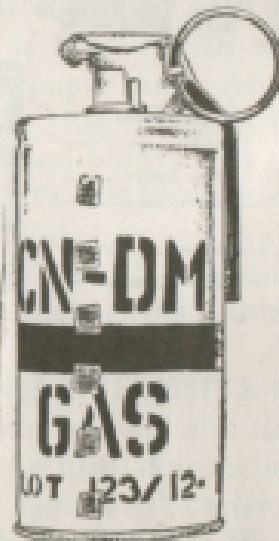


Figure 3. Frangible grenade M<sub>1</sub>, with igniter M<sub>3</sub>. (Safety pin ring may be either to the right or the left.)

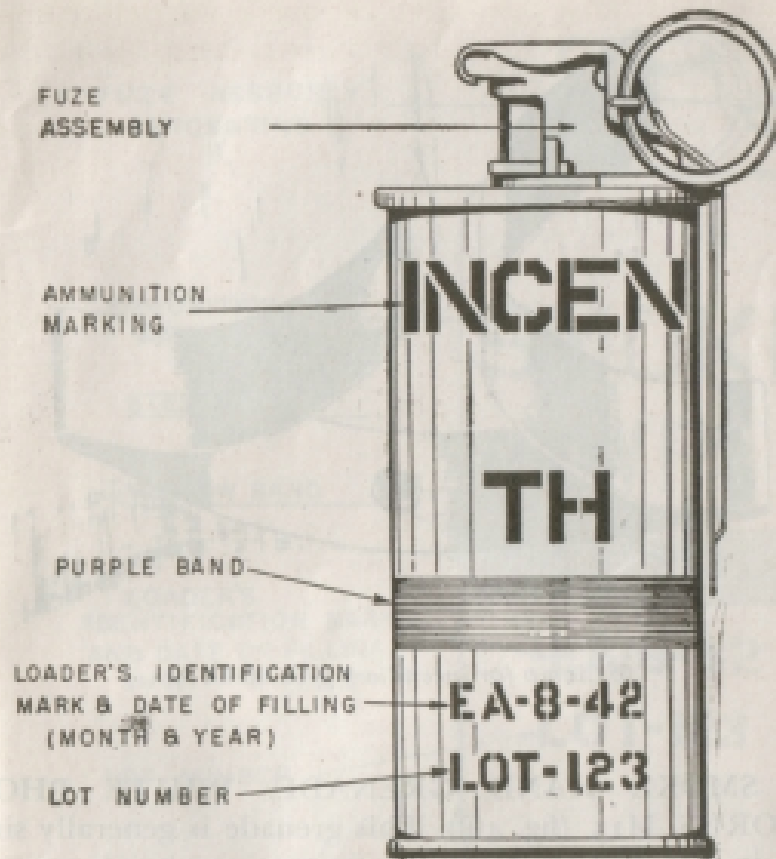
body, a striker, and a blank cartridge, and is fastened around the bottle with a Timmerman strap. Before throwing, the safety pin must be removed. When thrown, the bottle breaks, releasing the strap and strap safety. This permits the striker, which is actuated by the striker spring, to ignite the blank cartridge. The flash from the blank cartridge ignites the contents of the broken bottle.

(6) IRRITANT GAS HAND GRENADE, CN-DM, M6 (fig. 4①). This grenade has a cylindrical body made of tin plate. The body contains perforations or vents which are covered with squares of adhesive tape. When the grenade functions these patches are blown or burned off and the gas escapes. The chemical filler is composed of a mixture of CN-DM and a small amount of blank fire powder. Two seconds after the primer is fired, the grenade begins to generate a gas having a pungent odor. One second later the gas reaches full volume and the grenade functions for 25 to 35 seconds. This is a burning type grenade and does not explode.

Figure 4. Chemical Grenades.



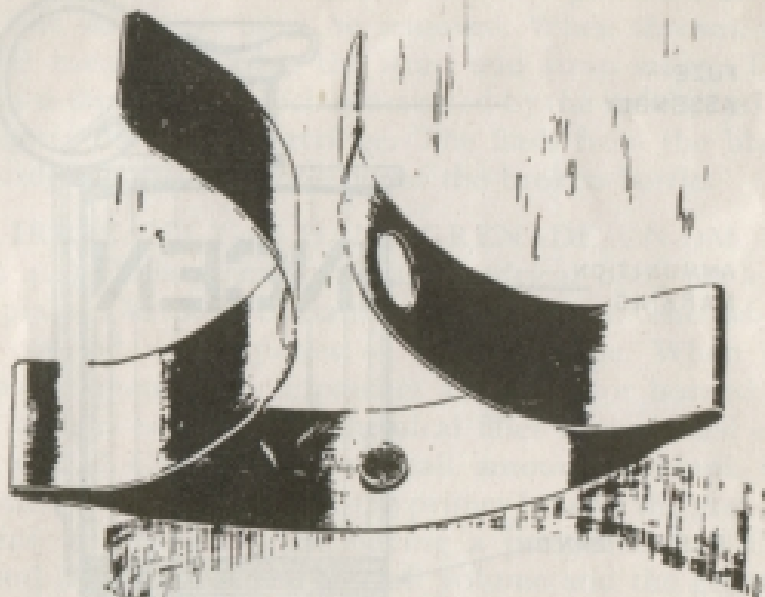
① Irritant gas hand grenade CN-DM M6.



② Incendiary grenade M14.

(7) IRRITANT GAS HAND GRENADE, CN, M7. This grenade is similar to the M6 grenade but is filled with CN only instead of the CN-DM mixture.

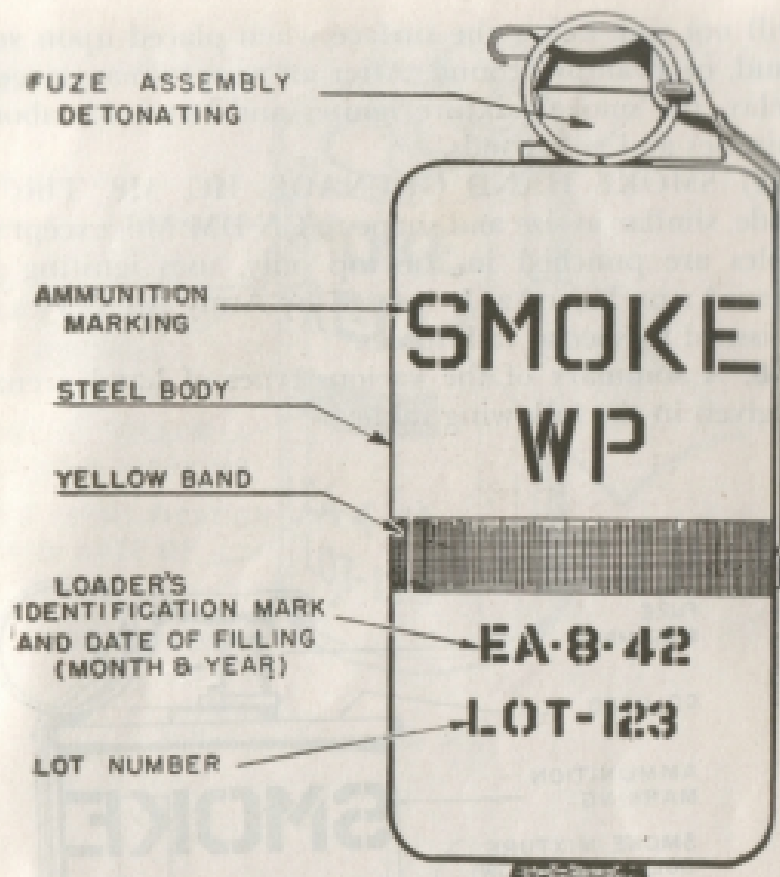
(8) INCENDIARY GRENADE M14 (fig. 4② and ③). This thermate-filled grenade is similar in size and shape to the irritant gas hand grenade CN-DM M6. It is equipped with an M200A1 igniting fuze. After a 2-second delay, the thermate ignites and burns for 30 seconds or longer. A clamp of strap metal is furnished with each grenade, into which the grenade can be placed to keep it from rolling when it ignites.



© Clamp for incendiary grenade M14.

(9) SMOKE HAND GRENADE, WHITE PHOSPHORUS, M15 (fig. 4②). This grenade is generally similar in size and shape to the irritant gas hand grenade CN-DM M6, but has rounded corners. It is equipped with the M6A3 detonating fuze with  $4\frac{1}{2}$ -second delay. This grenade is different from the other chemical grenades in that it is a bursting type grenade. On exploding, the solid pieces of WP will be scattered over an area about 25 yards in diameter and will burn for approximately 30 seconds.

(10) COLORED SMOKE HAND GRENADE M18 OR M16 (fig. 4②). This grenade is similar in size and shape to the irritant gas hand grenade CN-DM M6. It is equipped with the M200A1 igniting fuze with 2-second delay. Seven colors of smoke (red, orange, blue, green, black, violet, and yellow) are available. The mixture in



© Smoke hand grenade (WP) M15.

the M18 grenade burns for 1 minute and in the M16 (limited standard) grenade the mixture burns for 2½ minutes.

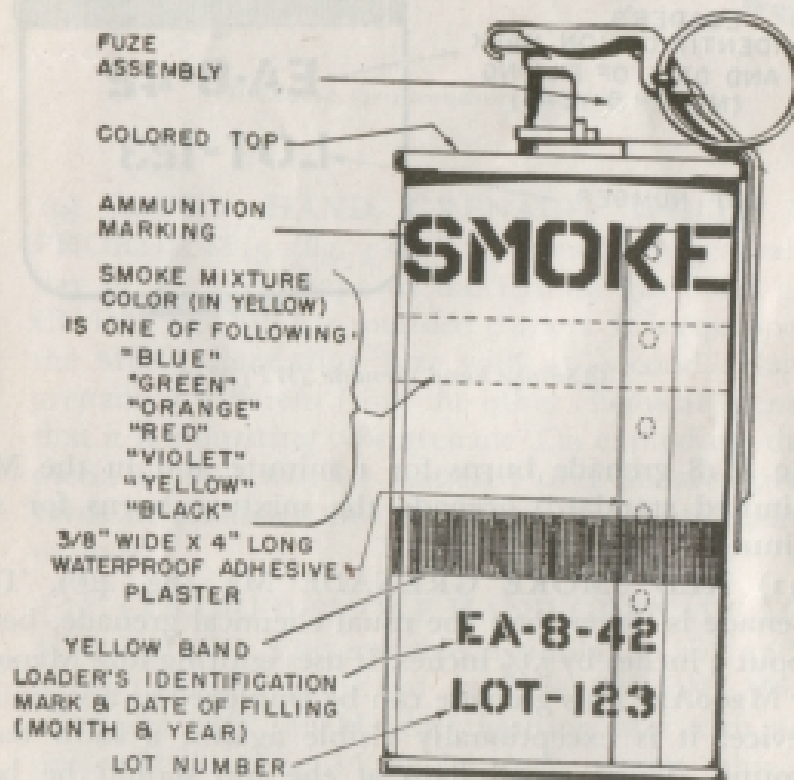
(11) RED SMOKE GRENADE M3 (fig. 4©). This grenade is larger than the usual chemical grenade, being about 3 inches by 5½ inches. It uses igniting fuze M200A1 or M200A2. This grenade can be employed as a signaling device; it is exceptionally visible against a snow background. Three metal flaps at the top should be bent upward to serve as additional bases so that the grenade



will not sink below the surface when placed upon snow, mud, or swampy ground. After an approximate 2-second delay, the smoke mixture ignites and burns for about 2 minutes and 30 seconds.

(12) SMOKE HAND GRENADE, HC, M8. This grenade, similar in size and shape to CN-DM M6, except that holes are punched in the top only, uses igniting fuze M200A1 or M200A2. It is used by Army Air Forces and is issued to special task forces.

b. A summary of the various types of hand grenades is given in the following table:



© Colored smoke grenade M18 or M16.



© Red smoke grenade M3.

### HAND GRENADES

Type	Fuze	Wt. as used (oss.)	Filler	Body	Range (yds.)	Radius of burst	Painting and marking	Use	Delay time
Grenade, hand, fragmentation Mk. II.	Igniting, M10A2, or M10A3.	20	EC blank fire powder.	Cast iron, serrated.	50	30 yards.	OD w/hat-row yellow band.	Casualty ..	4½ seconds, or 4 seconds.
Grenade, hand, practice, Mk. II.	Igniting, M10A1.	20	R e d u c e d charge black powder.	Cast iron, serrated.	50	Does not burst blows out cork plug.	Blue.....	Practice....	4½ seconds.
Grenade, hand, training, Mk. IAI.	None.....	20	None.....	Cast iron, serrated.	50	None.....	Black.....	Training and throwing practice.	Inert.
Grenade, hand, offensive, Mk. IIAI.	Detonating, M6A2.	11	TNT.....	Paper....	50	.....	Yellow, type model and lot in black.	Demolition	5 seconds.
Grenade, frag- gible, M1.	None.....	42	FS.....	Glass.....	25	5 yards.	None.....	Screening..	None.
	None.....	14	AC.....	Glass.....	25	5 yards.	None.....	Casualty ..	None.
	Igniter, M3	24	IM.....	Glass.....	25	5 yards.	None.....	Incendiary.	None.
	Igniter, M3	15	NP.....	Glass.....	25	5 yards.	None.....	Incendiary.	None.
Grenade, hand, gas, irritant, CN-DM, M6.	Igniting, M200A1.	17	CN-DM.....	Tinplate, smooth, cylindrical.	50	Burns; does not burst.	Blue gray, "CN-DM GAS" and 1 band (all in red).	Harrasing.	Fuses start in 2 seconds; full volume, 3 seconds.

Grenade, hand, gas, irritant, CN, M7.	Igniting M200A1.	17	CN.....	Tinplate, smooth, cylindrical.	50	Burns; does not burst.	Blue gray. "CN GAS" and 1 band (all in red).	Harrasing.	Fumes start in 2 seconds; full volume, 3 seconds.
Grenade, incendiary, M14.	Igniting M200A1.	32	TH.....	Tinplate, smooth, cylindrical.	.....	Burns; does not burst.	Blue gray. "TH INCENDIARY" and 1 band (all in purple).	Incendiary.	2 seconds.
Grenade, hand, smoke, W.P. M13.	Detonating M6A3.	32	WP.....	Tinplate, cylindrical.	50	25 yards.	Blue gray. "WP SMOKE" and 1 band (all in yellow).	Screening casualty, harassing.	4 1/2 seconds.
Grenade, hand, smoke, colored, (red, violet, orange, yellow, black, green, blue). M18 and M16.	Igniting M200A1.	17	Sulphur, potassium, chlorate, sodium bicarbonate, and dye.	Tinplate, smooth, cylindrical.	50	Burns.....	Blue gray. Lot, type, model, and 1 band (all in yellow). Color of filler on top of body.	Signal.....	2 seconds; full volume, 3 seconds.
Grenade, smoke, red, M1.	Igniting M200A1 or M200A2.	28	.....	Steel, cylindrical.	.....	Burns.....	Blue gray. "SMOKE RED" and 1 band (all in yellow).	Signal.....	Approximately 2 seconds.

## HAND GRENADES

Type	Fuze	Wt. as used (ozs.)	Filler	Body	Range (yds.)	Radius of burst	Painting and marking	Use	Delay time
Grenade, hand. smoke, HC, M8.	Igniting M200A1.	17	HC smoke mixture.	Tinplate, smooth, cylindrical.	50	Bursts; does not burst.	Blue gray. "HC SMOKE" and 1 band and lot (all in yellow)	Signal.....	Fumes start in 2 seconds; full volume, 3 seconds.

1 Issued fuzed ready for use.

\*Vapor will travel a considerable distance down wind.

## SECTION II

### TRAINING AND PRACTICE

**5. GENERAL.** Grenade throwing is the most important phase of hand grenade training. The thrower must strive to follow the method of arming and throwing so that in the latter stages of training these operations will be performed correctly through habit. Accuracy and distances are the desired factors in grenade throwing.

**a. Outline of instruction.** (1) Training in grenade throwing is divided into three steps:

- (a) Development of throwing technique.
- (b) Development of accuracy and distance.
- (c) Combat training.

(2) Training includes the throwing of the training hand grenades and the improvised frangible grenades as described in paragraph 6e. In developing throwing technique, any level field is suitable. In the first step, attention is focused on positions, holding of the grenade, the throw, and the trajectory.

(3) Proper throwing technique having been acquired, the soldier proceeds to the second step in which technique is combined with training in the development of accuracy and distance. This step in the training will be conducted on the practice course and will consist of throwing at varied and logical targets.

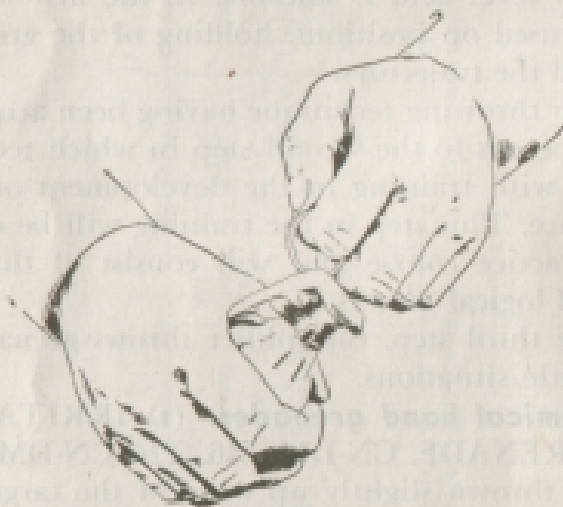
(4) In the third step, the soldier throws grenades in assumed battle situations.

**b. Chemical hand grenades.** (1) IRRITANT GAS HAND GRENADE, CN-DM, M6. The CN-DM grenades should be thrown slightly up wind of the target area so that the gas cloud will be carried to hostile personnel by the wind.

(2) **INCENDIARY GRENADE M14.** This grenade must be thrown to fall on combustible materials. For destroying such matériel as weapons and vital parts of vehicles which are difficult to ignite, the grenade should be placed in position (not thrown) before activating the primer. Since there is a definite movement of the grenade at the instant it explodes, it should be fastened in place whenever practicable in order to obtain the maximum incendiary effect. (See fig. 4ⓐ.)

(3) **FRANGIBLE GRENADE M1.** Frangible grenades must be aimed accurately and thrown with sufficient force to assure breakage.

**c. To hold grenade** (fig. 5) The grenade should be held in the right hand with the safety lever firmly pressed by the palm. The forefinger of the left hand is inserted through the safety pin ring. (A left-handed man may hold the grenade in his left hand.) In this position, the safety pin can be removed without altering the grip for throwing. The thrower must take every precaution after the safety pin has been withdrawn not to release his grip on



*Figure 5. Method of holding the grenade.*

the lever until the grenade is thrown. When preparing to throw the fragmentation hand grenade Mk. II, the thumb and forefinger of the right hand should be around the upper horizontal serration of the body with the palm slightly higher on the grenade to insure downward pressure on the lever. Otherwise, the lever may be released before throwing, or the fuze head may be caught by the fingers when thrown. For grip used in throwing the frangible grenade M1 see figure 10②.

**d. General rules for throwing.** The grenade should be thrown in a manner similar to the throwing of a forward pass in football. *The biceps muscle of the throwing arm should be contracted just before throwing.* The grenade is released just before the arm is fully extended. It is given a spinning motion by being released over the tips of the fingers as it leaves the hand so that it will rotate around its longer axis, fuze to the rear, during its flight to the target. The maximum range is obtained when the grenade leaves the hand traveling at an upward angle of 45°. The hand being at the shoulder, to execute the throw, carry the right hand forward and upward without twisting the wrist. The left arm always counterbalances the movement of the right arm. If the grenades are striking to the right or left of the target, the entire body should be shifted to the left or right. For the first practice no attempt should be made to throw more than 5 grenades, or to throw beyond a distance of 20 yards; the number of grenades thrown and the distance is increased as training progresses. Thirty-five yards is considered a good range after training has progressed. A 50-yard range is above average.

**6. METHODS FOR DEVELOPING TECHNIQUE.** Development of technique is the first step in grenade training. When the proper technique has been attained by throw-



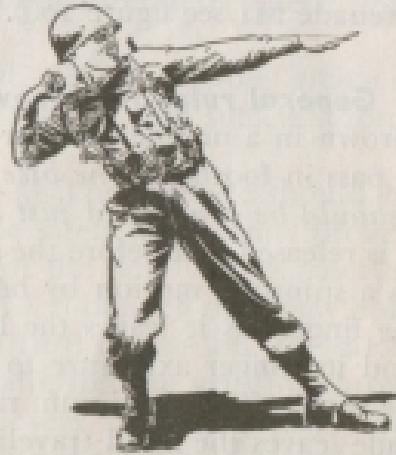
ing practice, the thrower develops accuracy and distance on the main, crater, fox hole, and vertical target courts.

**a. To throw from standing position** (fig. 6). The thrower facing the target, the commands and manner of execution are as follows:

*Figure 6. To throw from standing position.*



⊙ *Stand.*



⊙ *Prepare to throw.*



⊙ *Throw.*

(1) **STAND.** Face to the right. Move the left foot  $1\frac{1}{2}$  to 2 feet toward the target, with the toe pointing in the general direction of the target. Assume a well-balanced and easy position. With the hands down and in front of the center of the body, grasp the grenade in the prescribed manner. When dummy hand grenades are used, the left forefinger grasps the right thumb to simulate the grasping of the safety pin ring.

(2) **PULL PIN.** Pull out the safety pin with a twisting-pulling motion, holding the hands as nearly as practicable in front of the center of the body. When dummy grenades are used, simulate this movement.

(3) **PREPARE TO THROW.** Quickly bring the right arm into position, the elbow at the height of and on line with the shoulders, palm of the hand up, and near or touching the shoulder. At the same time extend the left arm, palm of the hand down, in the direction of the target. The weight of the body is on the right foot. The body is bent to the right, right knee bent, eyes sighting over the left hand to insure direction and then fixed on the target.

(4) **THROW.** Quickly move the right arm upward and to the front without twisting the wrist and release the grenade just before the arm is fully extended, being sure to impart a spinning motion.

(5) **RECOVER.** Resume the position of **STAND**.

**b. To throw from kneeling position** (fig. 7). The thrower, facing the target, executes the commands in the following manner:

(1) **KNEEL.** Face to the right, kneel on the right knee, right leg to the rear, left leg and foot pointing in the general direction of the target. The weight of the body is on the right knee.

(2) **PULL PIN.** The execution is the same as for the standing position.

(3) **PREPARE TO THROW.** The execution is the same as for the standing position except that the weight of the body is on the right knee.

Figure 7. To throw from kneeling position



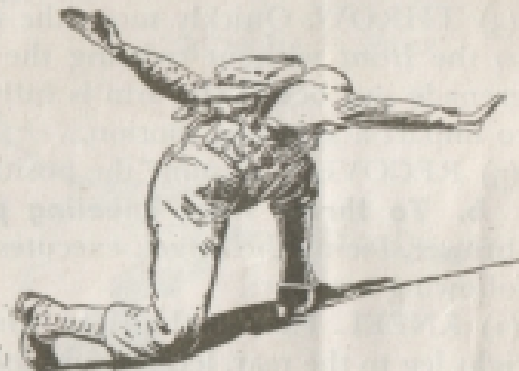
① Kneel.



② Prepare to throw.



③ Throw.



④ Follow through.

(4) **THROW.** The execution is the same as for the standing position except that the body is brought to rest by

the chest coming in contact with the left knee and upper leg at the completion of the throw.

(5) **RECOVER.** Resume the position of **KNEEL.**

**e. To throw from prone position** (fig. 8). The thrower, facing the target, executes the commands in the following manner:

(1) **LIE DOWN.** Assume a prone position, as shown in figure 8①. The body is on a line approximately in prolongation of the target, so that when the position **PREPARE TO THROW** is taken it will be unnecessary to shift the feet or left knee. Either cheek is near or on the ground.

(2) **PULL PIN.** Holding the grenade in front of the head as shown in figure 8①, pull the pin in the same manner as described for the standing position.

(3) **PREPARE TO THROW.** Draw back the hands and arms so that the hands are near the shoulders, left hand and forearm flat on the ground, right forearm and wrist *only* on the ground; shove the body upward, pivoting the weight of body on the left knee; straighten the right leg and extend it straight to the rear. Hold the body upright. Do not push up with the hand holding the grenade. Keep this hand clear of the ground as shown in figure 8②. Continue until a kneeling position is assumed. Being now in a kneeling position, kneeling on the left knee, assume the same positions for the hands, arms, body, and eyes, as given for the standing position.

(4) **THROW.** The execution is the same as for the standing position. Stop the forward motion of the body by placing the right hand on the ground after the throw, permitting the body to continue to the ground. This position will leave the right hand near the head and the left hand near the waist on the left side. The left hand can be used to carry another grenade to the right hand for the next throw.

(5) **RECOVER.** Place the left hand next to the right in front of the head. Resume the position of **LIE DOWN.**

Figure 8. To throw from prone position.



ⓐ Lie down.



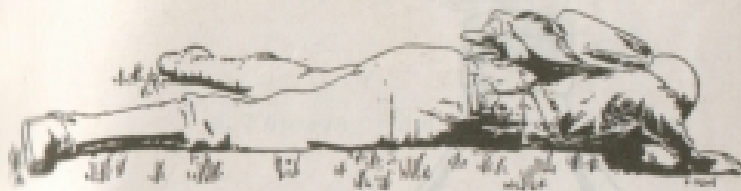
ⓑ Prepare to throw.



ⓒ Prepare to throw.



© *Throw.*



© *Return to prone position.*

**d. To throw from prone position (advancing)** (fig. 9). The body of the thrower can be advanced about 2 feet at each throw if this is desired. The commands and movements are the same as for the prone position except in **PREPARE TO THROW**. As the hands are brought back, advance the left knee as far as possible. The distance that the left knee is advanced is the distance that the body will be advanced for each throw.



*Figure 9. To throw from prone position (advancing).*

**e. To throw frangible grenades** (fig. 10). (1) All men must be trained in throwing frangible grenades at both stationary and moving targets. Bottles filled with water may be used as practice grenades.

(2) When the thrower is above the surface of the ground the grenade is grasped and thrown as shown in figure 10①, ②, ③, and ④. Note that the grenade is thrown with an underhand motion and allowed to roll off the finger tips so that it rotates about its longer axis. This prevents wobbling or tumbling in flight.

*Figure 10. Throwing frangible grenades.*



① Grip used to throw frangible grenades.

en  
th  
er  
  
nd  
re  
th  
ger  
nts



© *Throwing from crouching position.*



© *Throwing from standing position. Bottle is thrown with underhand motion allowing it to roll off fingers. Throw with easy motion, not too hard.*





③ *Point of release. Note palm of throwing hand.*



④ *Position in shell crater prior to taking throwing position.*



① *Throwing position from shell crater. Some back swing is necessary.*



② *Point of release of grenade. Bottle is allowed to roll off fingers. Thrower immediately drops back when grenade is released.*

(g) When the thrower is in a shell crater or fox hole, the grenade is still grasped as shown in figure 10① but is thrown with an overhand motion. (See fig. 10②, ③, and ④.)

**f. To throw grenades in towns, woods, or jungle.**

In built-up areas, woods, or jungle, a high degree of accuracy in throwing is necessary to take advantage of openings in buildings and foliage, and narrow lanes. The manner of throwing depends on whether the opening through which to throw is high or close to the ground.

(1) If it is necessary to throw over tall walls or brush or through an opening in walls or foliage some distance above the ground, the overhand method prescribed in paragraph 5d is applicable, except that the angle at which the grenade leaves the hand will depend on the height of the obstacle or opening.

(2) If the opening is close to the ground surface, the thrower will employ the underhand motion described in e above and figure 10② and ④. The grip for grenades other than frangible will be as described in paragraph 5c.

**7. PRACTICE COURSE.** The practice course includes courts (pars. 8 to 11) for throwing both training hand grenades and frangible grenades at varying distances and from all positions.

**a. Frangible grenades.** Practice throwing of frangible grenades, once technique is developed, will be conducted on the fox hole court with the addition of a 6- by 6-inch target placed at each fox hole. These targets represent tanks or other vehicles, and in order to score a hit the grenade must strike the upper half of the target. This restriction is necessary because, under field conditions, the maximum effect is secured from frangible grenades when they are broken high enough on the vehicle to ignite it and its contents.

**b. Transition training.** During the early stages of training, technique, accuracy, and distance are stressed

without regard to protection. However, before leaving the practice course, training should simulate the throwing of live grenades. In this training and in live grenade throwing practice, the thrower must be behind cover or assume the prone position after the throw. At each court the soldier will throw from all positions. When throwing from the standing and kneeling positions the thrower will assume the prone position. The weapon with which an individual is armed will be carried habitually during transition training.

**8. MAIN COURT** (fig. 11①). **a.** The court will be 40 yards wide and 35 yards long.

**b.** Targets are indicated by using strips of canvas or target cloth about 2 inches wide, placed 1 yard apart. The court has five such targets placed at the indicated distances from the throwing line.

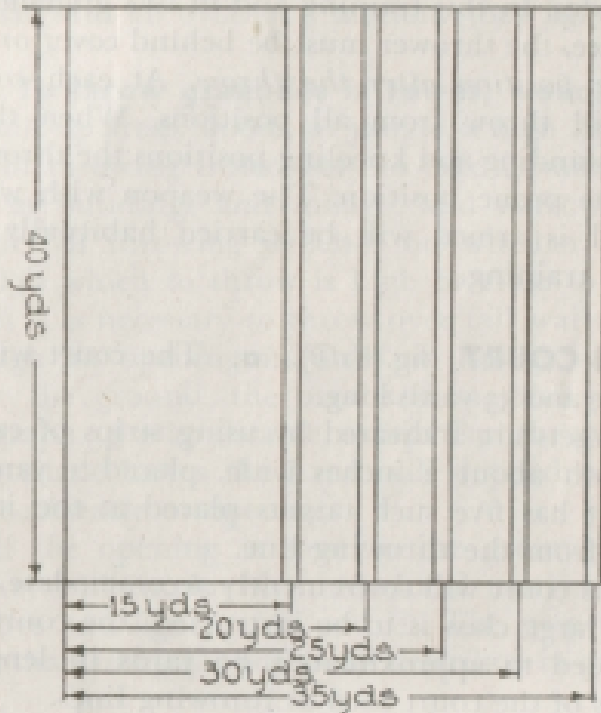
**c.** This court will conveniently accommodate 64 men. Where a large class is to be instructed, the court should be extended to approximately 60 yards in length and both ends of the court used as throwing lines.

**d.** The thrower places himself in rear of the throwing line. He throws at the first target until a direct hit is made on or between the two tapes, at which time he is eligible to throw at the next target. Accuracy in range is the object desired.

**e.** Accuracy in direction is the next objective. This is obtained by throwing at 1 yard squares marked off on the targets of the main court. The exercise is conducted in the same manner as indicated in **d** above.

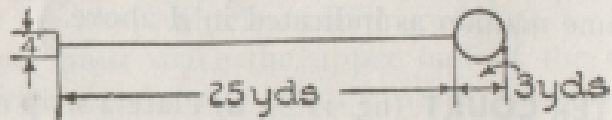
**9. CRATER COURT** (fig. 11②). **a.** Place a strip of canvas 4 feet long and 2 inches wide on the ground. At a distance of 25 yards to the front, dig a circular pit 3 yards in diameter and not less than 18 inches deep. To increase the number of men who can use this court at one time,

Figure 11. Practice course.



⊙ Main court.

Figure 11. Practice course.



⊙ Crater court.

the throwing tapes can be placed in a circle around the crater with the center of the crater as the center of the circle and a radius of  $26\frac{1}{2}$  yards.

**b.** The thrower places himself behind the throwing tape line. A grenade which first strikes the ground outside and then goes into the pit is not considered a hit.

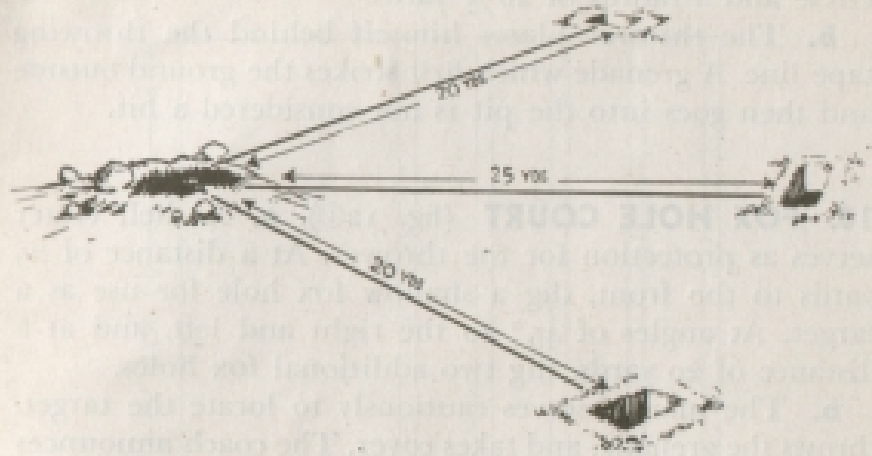
**10. FOX HOLE COURT** (fig. 12①). **a.** A shell crater serves as protection for the thrower. At a distance of 25 yards to the front, dig a shallow fox hole for use as a target. At angles of  $45^\circ$  to the right and left, and at a distance of 20 yards, dig two additional fox holes.

**b.** The man observes cautiously to locate the target, throws the grenade, and takes cover. The coach announces "Hit" or "Miss." A grenade that first strikes the ground and then goes into a fox hole is not considered a hit during this practice. The object is to hit each of the three targets in turn with the least number of grenades.

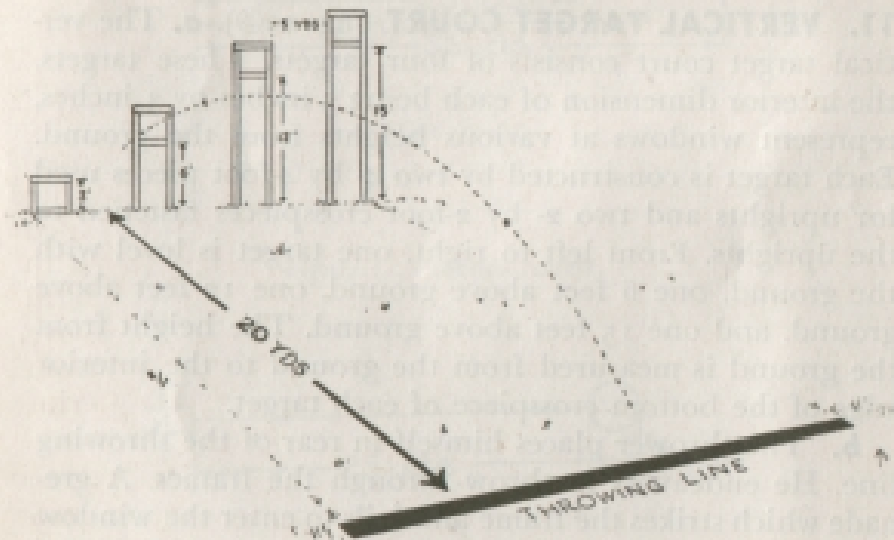
**11. VERTICAL TARGET COURT** (fig. 12②). **a.** The vertical target court consists of four targets. These targets, the interior dimension of each being 3 inches by 3 inches, represent windows at various heights from the ground. Each target is constructed by two 4- by 4-foot pieces used for uprights and two 2- by 2-foot crosspieces fastened to the uprights. From left to right, one target is level with the ground, one 6 feet above ground, one 12 feet above ground, and one 15 feet above ground. The height from the ground is measured from the ground to the interior edge of the bottom crosspiece of each target.

**b.** The thrower places himself in rear of the throwing line. He endeavors to throw through the frames. A grenade which strikes the frame and fails to enter the window is not considered a hit. The object is to hit each of the four targets in turn with the least number of grenades.

Figure 12. Practice course.



⊙ Fox hole court.



⊙ Vertical target court.

## SECTION III

### COMBAT TRAINING

**12. USE OF HAND GRENADES IN COMBAT.** The hand grenade is used at short ranges against enemy personnel, especially weapon crews of other small groups so located as to be protected from rifle fire and who are inside the minimum range of high-angle rifle grenade fire.

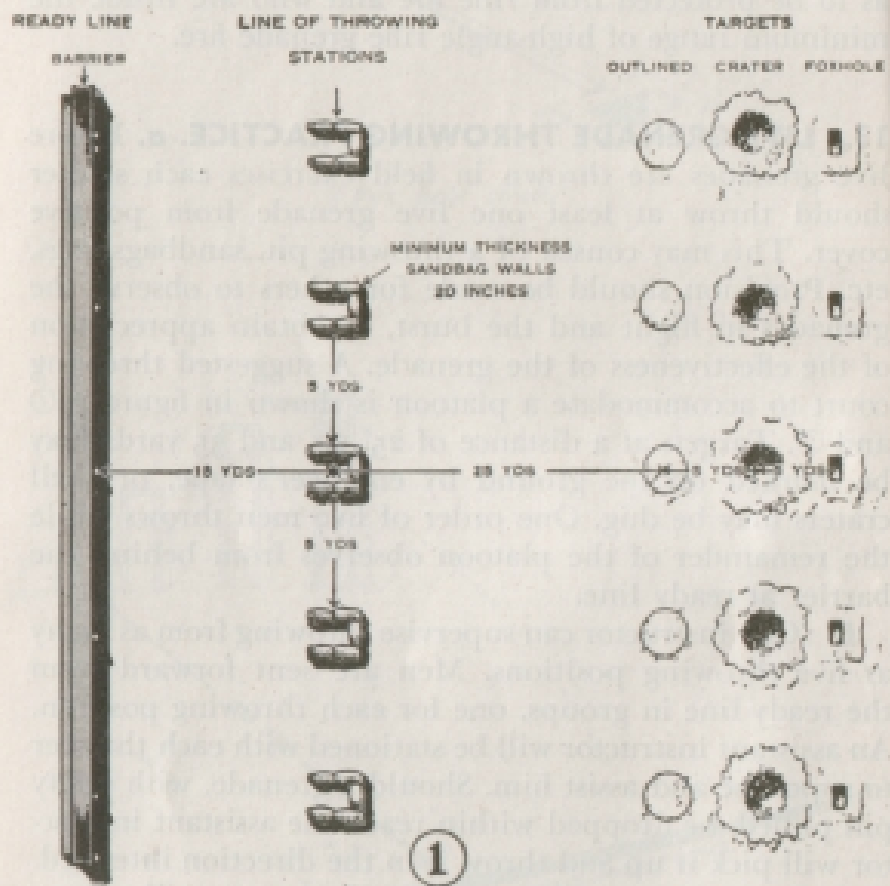
**13. LIVE GRENADE THROWING PRACTICE.** **a.** Before live grenades are thrown in field exercises each soldier should throw at least one live grenade from positive cover. This may consist of a throwing pit, sandbags, logs, etc. Provision should be made for others to observe the grenades in flight and the burst, to obtain appreciation of the effectiveness of the grenade. A suggested throwing court to accommodate a platoon is shown in figure 13① and ②. Targets at a distance of 25, 30, and 35 yards may be marked on the ground by engineer's tape, or shell craters may be dug. One order of five men throws while the remainder of the platoon observes from behind the barrier at ready line.

**b.** One instructor can supervise throwing from as many as five throwing positions. Men are sent forward from the ready line in groups, one for each throwing position. An assistant instructor will be stationed with each thrower to supervise and assist him. Should a grenade, with safety pin pulled, be dropped within reach the assistant instructor will pick it up and throw it in the direction intended. Only one thrower and the assistant instructor will occupy a throwing position at one time.

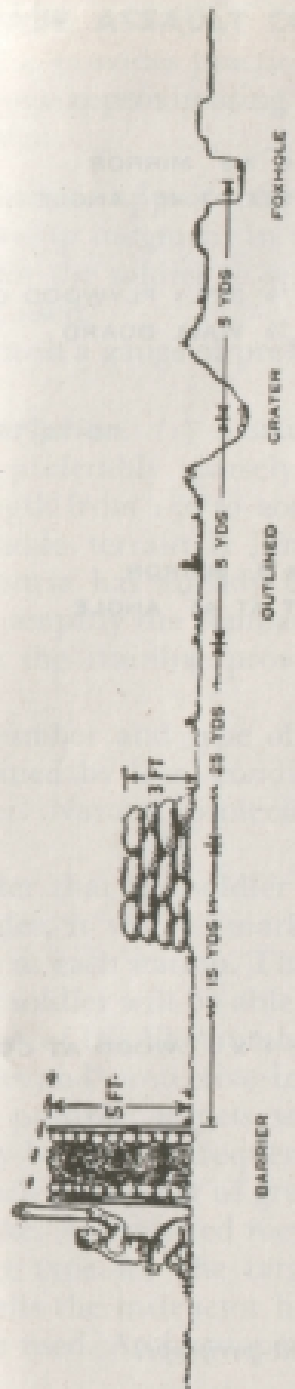


c. The barrier for the ready line should be at least 5 feet high and 20 inches thick, and so placed as to permit men on the ready line to observe with improvised periscopes (fig. 13<sup>ⓐ</sup>).

Figure 13. Live grenade practice course.



ⓐ Plan.



READY LINE

BARRIER

5 FT.

15 YDS

25 YDS

3 FT.

LINE OF THROWING STATIONS

5 YDS

5 YDS

5 YDS

OUTLINED

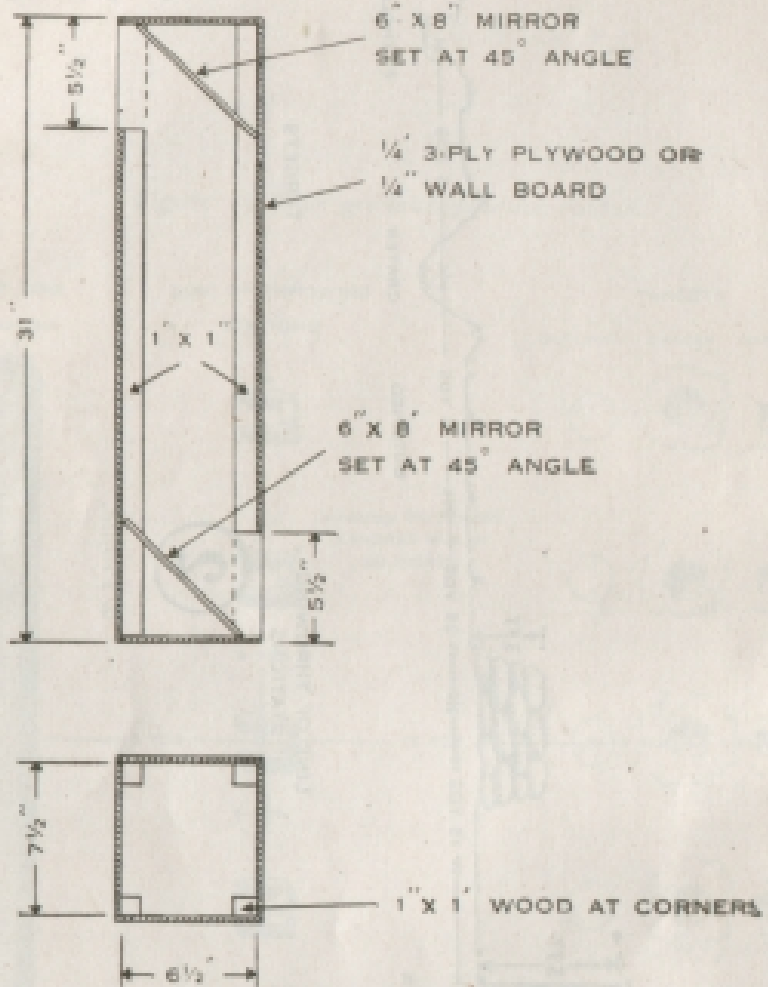
CRATER

FOXHOLE

TARGETS

2

© Profile.



③

③ *Improvised periscope.*

**14. GRENADE ASSAULT COURSE. a. Purpose.** The assault course provides practice in throwing grenades under conditions approximating combat and has the following objectives:

- (1) To illustrate appropriate targets.
- (2) To develop judgment in the use of protective cover.
- (3) To train the soldier to select the proper type of grenade to be used.
- (4) To furnish a gauge of proficiency in grenade training.

**b. Description.** (1) Assault courses will be laid out on rough, preferably sparsely wooded terrain, and may vary in length from 150 to 200 yards. At posts or stations where suitable terrain is limited and where a combat reaction course has already been constructed, it is permissible to amplify the combat reaction course sufficiently to include the training provided for in paragraphs 14 and 15.

(2) The number and type of targets on the course will be determined by local conditions and the ingenuity of the builder. Natural protection should be used where possible.

(3) In order that the soldier may run the course in the desired order, it will be marked with serially numbered stakes, one at each station. The course will be constructed so that the soldier will be able to pick up each target from the location of the like-numbered stake.

(4) Targets and protective installations will be logically placed. If possible, targets will be movable so that the course may be altered frequently.

(5) A sufficient number of grenades will be placed at each station stake. A suggested method is to place grenades of the correct type for the target in a *covered* box. The thrower tells the instructor his choice of the type of grenade to be used. An improper choice will be immediately corrected.

**15. RUNNING THE COURSE. a.** Only one group of soldiers will run the course at one time. The next group will not start until the instructor of the preceding group has signaled that his group is in the clear. Small groups of three or four men are most desirable. While one man throws, other members of the group observe and critique the actions and behavior at each station before proceeding to the next station. Soldiers will carry their individual arms while running the course.

**b.** An instructor will run the course with each group to correct errors and to observe the following:

- (1) Use of cover and protection.
- (2) Type of grenade selected for use.
- (3) Choice of throwing position.
- (4) Throwing technique.
- (5) Accuracy.
- (6) Action upon explosion of the grenade.

**c.** Because of variations in local terrain and differences in the placement of targets, no time limit can be set. However, prompt action must be demanded.

**d.** The soldier must realize the necessity for proper protection when throwing grenades. Thus, after he has reached the station and located the target he must pick out the best available cover from which to make his throw and proceed to it without hesitation. Usually this requires crawling and making use of cover en route.

**e.** An appropriate sequence for throwing grenades under combat situations is as follows:

- (1) Secure cover.
- (2) Pull pin.
- (3) Throw grenade.
- (4) Drop back to cover.
- (5) Upon the explosion, close in quickly with the bayonet to kill any remaining enemy.

**f.** For variation, the course may include points where incendiary or smoke grenades may logically be used.

**g. Grenade assault course (suggested).**

Station No.	Protection	Target	Distance (yards)	Grenade
1	Log	Machine gun emplacement.	25	Training hand grenade
2	Wall	Window	10	Training hand grenade
3	Fox hole	Bobbing targets from trench.	25	Training hand grenade
4	Shell crater	Tank mock-up	20	Frangible
5	Earth	Mortar emplacement.	30	Training hand grenade
6	Log or other natural barrier	Prone dummies pulled by rope behind bush.	25	Training hand grenade
7	Fox hole	Tank mock-up (moving).	25	Frangible
8	Ditch (shallow)	Fox hole	25	Tangible hand grenade

Note: Live grenades may be used at some stations.

**14. FIELD TRAINING. a.** The next step in training is throwing live fragmentation grenades during small unit combat firing exercises.

**b.** A suggested exercise is to have a rifle squad close to assaulting distance of a represented hostile machine-gun emplacement under cover of fire from the automatic rifle team firing ball ammunition on the target from an appropriate supporting locality.

**c.** A soldier is then designated to crawl forward and throw a live fragmentation grenade into the emplacement. When the grenade explodes, the automatic rifle team ceases firing and the riflemen move in quickly to kill any remaining enemy in the emplacement and any other enemy in the immediate vicinity. The exercise may be repeated with a different soldier being designated to throw the grenade.

**d.** Dummies should be placed in the emplacement and around the area as bayonet targets.

**e.** Throwing live fragmentation grenades is continued during combat training and will be used where they would be employed logically in combat.

f. The practice grenade, containing a reduced charge, may be used to augment the supply of fragmentation grenades.

## SECTION IV

### SAFETY PRECAUTIONS, POLICE OF RANGE, AND DESTRUCTION OF DUDS

**17. GENERAL.** The provisions of this section pertain to throwing or handling live hand grenades. Other information necessary for safety, administrative, and supply purposes by company and higher headquarters is found in the references listed in the appendix.

**18. TO THROW OR TO HANDLE LIVE HAND GRENADES OR PARTS THEREOF.** The following safety precautions will be observed in addition to those prescribed in succeeding paragraphs for particular types of grenades:

a. No man will throw a live grenade until he has satisfactorily demonstrated proficiency in throwing training grenades.

b. Any alteration of loaded ammunition, except in accordance with specific instructions from the chief of the supply service concerned, is hazardous and is therefore prohibited.

c. A fuze containing a detonator should be handled with extreme care at all times. The detonator contains a charge of mercury fulminate composition and this explosive is very sensitive to heat, shock, or friction. By heat

is meant such conditions as the direct rays of the sun when the temperature is 70° F. or more. By *shock* is meant such shock as is produced by carrying fuze assemblies loose in the pocket where the detonators strike against each other, dropping them from any height whatever, or striking a box of fuze assemblies with a hammer in order to open the box. By *friction* is meant any friction more than is met during the ordinary handling of the fuze assembly at the end away from detonator. It is not necessary to touch the detonator of the fuze assembly. No attempt should be made to alter or tamper with a detonating fuze in the field. The detonator is powerful enough to blow fingers from a hand or cause other serious injury. If at any time it is necessary to handle detonators alone, grasp the open end and not the closed end. If handled carefully, detonators are not dangerous.

**d.** If a grenade is dropped after the safety pin has been removed or the striker has been allowed to function accidentally, the proper procedure is to pick up the grenade immediately, throw it in the direction intended, and seek nearby shelter. If no shelter is near, drop flat on the ground with the helmet toward the grenade. A grenade can be thrown farther than one can run in 3 or 4 seconds.

**e.** Do not pull out the safety pin until ready to throw.

**f.** Do not release the safety lever before throwing.

**g.** In case the safety pin will not pull out, do not straighten it until just before throwing the grenade. In the majority of grenades it will not be necessary to straighten the ends of the safety pins as a twisting-pulling motion readily removes them.

**h.** Do not recover or tamper with a live grenade that fails to fire (dud). They will be recovered and destroyed only as prescribed in paragraphs 23 and 24.

**i.** Do not take a *dud* apart.

**j.** Do not take any grenade apart unless ordered to do so.



**k.** When throwing chemical grenades containing toxic or irritant gases, all personnel within 200 yards of point of burst will wear gas masks.

**l.** For instructions concerning handling, care, and storage of grenades see FM 3-15.

**m.** In throwing grenades in built-up areas, woods, or jungle, care must be exercised to avoid hitting intervening obstacles such as walls, trees, and vines which might deflect the course of the grenade or cause it to bounce back on friendly troops. In such areas, the location of friendly troops must be known to avoid endangering them.

### **19. TO THROW FRAGMENTATION GRENADES.**

When live fragmentation grenades are thrown, the following precautions will be taken:

**a.** Personnel within a radius of 250 yards will wear steel helmets.

**b.** Grenades must be thrown to obtain ground bursts.

**c.** When grenades are thrown from a fox hole, weapon emplacement, or crater, or from behind a barrier, the thrower must avoid striking his hand or the grenade against the wall of the intrenchment or crater, or against the barrier. He must not expose any part of his body after releasing the grenade.

**d.** When a man who is not protected by a terrain feature, intrenchment, crater, or barrier, throws a grenade he will drop immediately to a prone position, face down, with his helmet toward the grenade. His arms and legs must be flat against the ground. Other individuals who are exposed will drop to a similar position.

**e.** Sandbag walls at least 20 inches thick or equivalent protection may be provided for coaches, officers in charge of firing, assistant instructors, or nonparticipants in instruction.

**f.** Grenades must be thrown so that they explode at least 40 yards from all individuals who are not behind cover.

**20. TO THROW CHEMICAL GRENADES.** Except where incendiary action is desired, incendiary type grenades should not be ignited within 5 feet of dry grass or other inflammable material, nor should they be fired closer than 30 feet from personnel. Thrower, or friendly troops, should not be directly down wind unless protected by gas masks.

**21. TO THROW PRACTICE GRENADES.** **a.** Practice hand grenades are practically free from hazard when properly used but they require the same degree of care in handling and operation as the standard live grenades.

**b.** The practice grenade described in paragraph 4a (2) may be thrown a safe distance by the average thrower, but personnel should take cover for the purposes of training. The steel helmet should be worn. Although there is practically no danger involved, personnel should remain at a safe distance.

**c.** Practice grenades that fail to function (duds) will not be recovered until at least 10 minutes have elapsed, and should be handled by experienced personnel.

**22. TO FUZE LIVE GRENADES.** **a. HE grenades.** Grenades may be issued which are filled with TNT and have detonating fuzes. Since the detonation of such grenades will set off adjacent grenades, they will be shipped, stored, and issued with the grenade body and fuze assembly separate. The grenade bodies have shipping plugs screwed into the fuze seats. These grenades are fuzed as follows:

- (1) Clear fuze cavity.
- (2) Examine fuze cavity. If the cavity is not clear or is not of sufficient size to receive the fuze without friction, use a wooden stick about  $\frac{1}{4}$  inch in diameter to enlarge the cavity.
- (3) Insert the fuze into the grenade body.

(4) Hold the fuze in one hand and *screw the grenade body into the fuze* with the other hand. In this operation the fuze should be the stationary part and the grenade body the moving part. A wrench is packed in each box of detonating fuzes and this should be used to seat the fuze firmly into the grenade.

**b. Special precautions.** Unfuzed grenades will not be fuzed in ammunition dumps or storage magazines, or within 100 yards of adjacent buildings, or in greater quantities than are needed for immediate use. Detonating fuzes and grenades containing phosphorus will be stored and transported separately from other explosives.

**23. POLICE OF RANGE. a. General.** After throwing live grenades and before free access to the range is allowed to personnel, the range will be policed thoroughly and all duds will be destroyed by competent personnel as prescribed in paragraph 24.

**b. Personnel employed.** The police of the range will be under the direct supervision of a commissioned officer who is thoroughly familiar with the prescribed methods of destroying grenades. The personnel engaged in this work should be given instruction as to the exact procedure to be followed and made thoroughly familiar with the danger of handling or disturbing the duds.

**c. Inspection of range after policing is completed.** After the destruction of duds has been completed the officer in charge of the work will personally superintend a thorough police of the area in order to insure that no duds have been overlooked. This is essential both for the protection of troops using the range at a future time and to eliminate accidents to persons who might carry away duds as souvenirs.

**d. Finding of duds.** All personnel, both military and civilian, who may find a dud should be warned of the dangers involved in handling them. They should be c

ected to report immediately the location of the dud to responsible military authority.

#### **24. METHOD OF DESTROYING GRENADE DUDS. a.**

**Demolition with TNT blocks.** (1) Individual fragmentation grenades can usually be destroyed in place with a  $\frac{1}{2}$ -pound block of TNT or a stick of dynamite placed in intimate contact with the dud and covered with a few shovelfuls of earth. The firing may be accomplished by means of a time fuze and a blasting cap or by a magneto with suitable electric blasting cap. In the event time fuze is used, approximately 1 foot of the fuze will be burned prior to use to insure that the proper type is at hand.

(2) All fragmentation hand grenades are of the *time fuze* type, that is, they are designed to explode on the burning through of a piece of time fuze. This type of grenade dud can safely be picked up and destroyed at some central point, except that before a fragmentation hand grenade is picked up, the striker should be looked at to make certain that it is all the way down against the primer. If the striker is not all the way down against the primer, but has rotated only part of the way, it is called a "hung striker." Such a grenade dud should not be picked up but should be destroyed where it lies, using extreme care in placing the demolition charge to prevent jarring the grenade. Chemical-filled and practice grenade duds with hung strikers can be picked up with safety because they can be thrown out of danger range in case the striker happens to function.

(3) When it is considered safe to move them, not to exceed 30 or 40 grenades are stacked in a small hole dug in the ground about  $1\frac{1}{2}$  feet or more in depth, care being taken that the bodies of the grenades are in close contact. For example, 40 grenades may be arranged by placing four side by side and four more base to base with those for the bottom layer and putting four similar layers directly

on top of this. A number of  $\frac{1}{2}$ -pound TNT blocks are then placed on top of the grenades. The number of TNT blocks to be used will depend on the number of grenades to be destroyed at one time. One block is sufficient for six grenades piled in three layers of two grenades each. At least two blocks should be used on twelve grenades piled in three layers of four grenades each. Five or six blocks should be used to explode 30 or 40 grenades.

(4) Where as many as five or six TNT blocks are used, it is preferable to arrange these by placing four of them side by side on top of the grenades in close contact and placing the remainder on top of this layer.

(5) The desired length of time fuze is cut (time fuze should be tested to determine rate of burning). One end of the fuze is placed carefully in the open end of a No. 8 detonator until it just touches the fulminate of mercury charge. Crimp the open end of the detonator tightly to the fuze by means of a fuze crimper, care being taken not to press the fuze tightly against the fulminate of mercury charge. (A cap should never be crimped to a piece of fuze with the teeth, as this is extremely dangerous.) The detonator is inserted into one of the topmost blocks of TNT.

(6) The grenades and TNT blocks are then covered by a mound of earth at least a foot deep and tamped lightly in order to obtain the maximum efficiency from the TNT.

(7) With the grenades underneath the TNT charge, there is less scattering of fragments and any grenades which happen to escape destruction will be left in the crater. These can then be destroyed by a second shot.

(8) The amount of earth covering used in the method described is entirely insufficient to prevent fragments of the grenades from being thrown to a considerable distance. It is not unusual for these grenade fragments to be thrown as far as 500 yards. All roads and other approaches

to the range should be properly guarded or red flags and warning notices posted. A safe bombproof shelter, built of logs or other suitable material, must be erected on the range so that the personnel carrying out the work can take shelter when the blasts are fired. No blast will be fired until every precaution is taken to insure that no one is within range of fragments or is likely to come within range before the charge explodes. This method is suitable for destroying high-explosive grenades only.

**b. Destroying by means of fire.** Grenades are destroyed by means of fire either one at a time or in bulk, depending upon their explosive characteristics.

(1) INDIVIDUAL DESTRUCTION. (a) Individual destruction by fire is applicable to all fragmentation grenades but particularly to the fragmentation hand grenade Mk. II with M10A2 or M10A3 igniting fuze. Being loaded with EC blank fire powder and bearing the M10A2 or M10A3 igniting fuzes, these grenades are not susceptible to mass detonation. This same method of destruction is especially suitable for destroying practice or other types of grenades which contain no explosive except the detonator, and which therefore are not readily disposed of by use of TNT blocks.

(b) A pit is dug in the ground about 2 feet square by 3 feet deep, and a loosely fitting cover of iron plate or heavy boards provided. A fire of wood or coke is built in the bottom of the pit, and when a substantial bed of hot coals has been produced, one of the grenades to be destroyed is dropped in, the cover is quickly dropped in place, and the operator takes shelter *until the grenade has exploded*. Grenades should be put in the fire one at a time, so that there will be absolutely no doubt as to whether or not there is an unexploded grenade in the pit. If there is unusual delay in exploding, no attempt should be made at that time to investigate. The time to investigate is after the fire has burned out and the pit is cold.

This procedure may be modified by providing an inclined chute, such as a piece of pipe, placed so that one end is over the center of the pit and the other behind a suitable barricade. Precaution should be taken to baffle the open end of the chute so that the operator cannot look down the chute. The grenades should be fed into the fire through the chute, care being taken to avoid an accumulation of unexploded grenades or components in the pit.

(2) **BULK DESTRUCTION** (a) Certain types of grenades with detonating fuzes and a filler of high explosive, if destruction by fire is necessary, are best destroyed in bulk lots of from 30 to 40 grenades. However, they may be destroyed one at a time as prescribed in (1) above if so desired. These grenades, being loaded with TNT and containing the fulminate of mercury detonator, are subject to mass detonation if one of the detonators explodes.

‡ (b) A pit similar to that used for destroying fragmentation grenades by detonation is necessary, and a heavy metal cover should be provided to stop flying fragments and unexploded grenades. A layer of inflammable material, such as wood or coke, should be placed under the pile of grenades, and as soon as the fire is started, the cover should be placed over the pit and the personnel should take cover.

c **Destruction of irritant or other types of chemical grenades.** The destruction of irritant or other types of chemical grenades which fail to function should be accomplished under the supervision of the unit chemical officer.

## SECTION V

### ADVICE TO INSTRUCTORS

**25. GENERAL.** a. Hand grenade training must not be restricted to hard and fast rules. Instructors must be con-

standby on the alert for new methods of training and operation, and nothing contained in this manual is to be construed as limiting in any way the initiative and originality of instructors.

**b.** Training in throwing grenades should be gradual. If the soldier throws a large number of grenades at the beginning of training, not only is he throwing more than he normally would in combat, but his arm will become lame, hindering his further training.

**26. SCOPE OF TRAINING. a. General.** The schedule of instruction and scope of training will depend upon the length of time available and the combat duties of the personnel to be trained. Practice in throwing in improvised towns and in woods should be included. The scope should include such instruction as will form the basis for the effective use of the grenade in the combat training of the smaller rifle units. To facilitate their recovery when throwing in woods, practice grenades may be dipped in white or colored paint.

**b. Individual instruction. (1) SCOPE.** The scope of individual instruction should include —

- (a) Characteristics, mechanism, and care and use of service type grenades.
- (b) Technique of throwing, including the throwing of training and live hand grenades.
- (c) Precautions pertaining to duds.
- (d) Combat training.

**(2) GRENADE THROWING.** Grenade throwing is the most important phase of individual grenade training and a very high standard of accuracy should be required, for besides the advantage it gives in combat it diminishes the risks of accidents and the consumption of grenades.



**c. Allotment of time.** The following apportionment of time allotted to this training is suggested:

Day	Time allotted (% of total)	Instruction	Equipment
1st	10%	Conference and demonstration (Sec. I and pars. 5 and 6).	Sample grenade of each type issued to unit; sample of foreign grenades, if available; time fuzes; fillers; primacord; training hand grenades; practice grenades. Level, open field.
2d	15%	Conference, demonstration, and practical work; throwing technique, all positions (pars. 5 and 6).	Training hand grenades; improvised frangible grenades. Level, open field.
3d and 4th	25%	Conference, demonstration, and practical work. Review of throwing technique (pars. 5 and 6); practice course (pars. 7 to 11, incl.).	Training hand grenades; improvised frangible grenades; practice grenades. Practice course.
5th and 6th	50%	Conference, demonstration, and practical work. Combat training; see III and so much of sec. IV as applicable.	Training hand grenades; live fragmentation and frangible grenades; $\frac{1}{2}$ -pound blocks of TNT, time fuzes, detonating caps (for destruction of duds). Live grenade practice course. Assault course.

**NOTE.** Training with grenades can reach perfection only with daily practice. It is suggested that training hand grenades be made available to men for off-duty practice. A miniature grenade course similar to a golf course can be constructed in the area near the barracks, offering soldiers an opportunity to compete with one another.

**27. CONDUCT OF TRAINING. a. Assistant instructors.** (1) A number of noncommissioned officers should be trained in advance for use as assistant instructors during the training of the remainder of the organization.

(2) An assistant instructor should be in charge of each throwing station of the live grenade practice course under the supervision of the officer in charge of the instruction (par. 13).

**b. Method of instruction.** (1) Instruction should be both theoretical and practical and these two phases

should be carried on simultaneously, the one serving as a relief for the fatigue induced by the other.

(2) Instruction periods should be short and full of interest.

(3) Instruction should be imparted by means of explanation, demonstration, and imitation. The instructor explains the several subjects covered. Concurrently with his explanation, assistant instructors demonstrate the operation. Following this, each student performs the operation closely supervised by the assistant instructors. The coach-and-pupil method will be used during the preliminary training; only instructors and assistant instructors supervise live grenade throwing practice and running the grenade assault course.

(4) Training must be carried out under the strictest discipline, as a careless man with a live grenade is a danger to himself and to his comrades.

(5) Throwing practice, after the initial stages of instruction should be conducted under service conditions, the men being equipped with the rifle, bayonet fixed, and pack less the roll.

(6) Certain theoretical instruction may best be imparted by short conferences given to the assembled organization. Wherever possible, these conferences should be illustrated by training films and film strip, charts, working models, and sectionalized or inert parts of the grenades or accessories being discussed.

**28. EQUIPMENT. a.** A special effort should be made to have on hand from the outset all grenades and other equipment that will be required during a course of training. Equipment should be carefully made and in excellent condition. Throwing courts, trenches, emplacements, etc., should be made according to required specification; if this equipment is old or has been in disuse, it should

be repaired prior to the time it will be needed for training purposes.

b. To insure the availability of the material at the place and time and in the quantities required, an accurate list of all the material needed for each individual period of training should be prepared. Careful advance planning along this line will heighten the standard of training, avoid delays between phases, and assist in obtaining the maximum amount of training in the period allotted.

## CHAPTER 2

# RIFLE GRENADES

---

### SECTION I

#### GRENADES, ACCESSORIES, SEQUENCE OF OPERATIONS, AND MECHANICAL TRAINING

**29. GRENADES.** With the aid of a launcher, rifle grenades may be fired from U. S. rifles, caliber .30, M1, M1903, M1903A1, M1903A3, and M1917; and from the U. S. carbine, caliber .30, M1, M1A1, and M1A3.

**a. Types.** Rifle grenades are divided into four general classes:

(1) Practice (training) grenades containing no explosives as follows:

(a) Practice antitank rifle grenade M11A1.

(b) Practice antitank rifle grenade M11A2.

(2) High-explosive or fragmentation grenades containing an explosive charge, as follows:

(a) Antitank rifle grenade M9A1.

(b) Impact fragmentation rifle grenade M17 (formerly the T2).

(c) Fragmentation hand grenade Mk. II (used with adapter M1).

(3) Pyrotechnic signals equipped with the fin assembly to permit them to be fired from the launchers, as follows:

• (a) Ground signal, white star; parachute, M17A1; cluster, M18A1.

(b) Ground signal, green star; parachute, M19A1; cluster, M20A1.

(c) Ground signal, amber star; parachute, M21A1; cluster, M22A1.

(d) Ground signal, red star; parachute, M51A1; cluster, M52A1.

NOTE. There is a "B2" model for each signal listed above (example, M17A1B2), which has a steel barrel instead of an aluminum one.

(4) Smoke rifle grenade (WP) T5.

**b. Nomenclature.** For nomenclature of antitank rifle grenades, see figure 14.

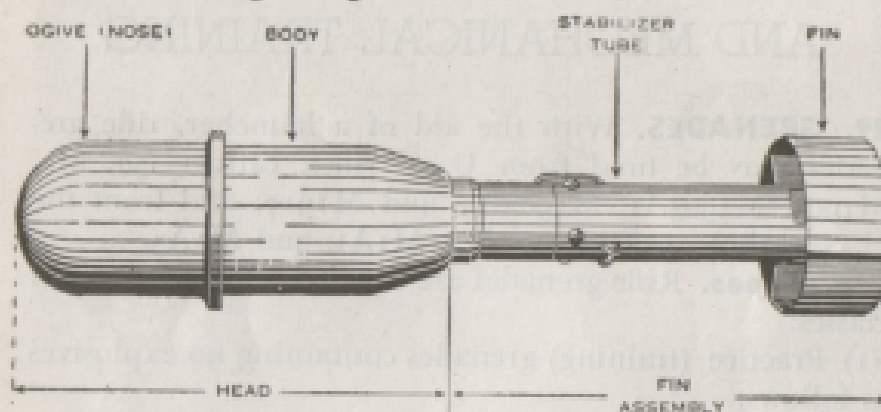


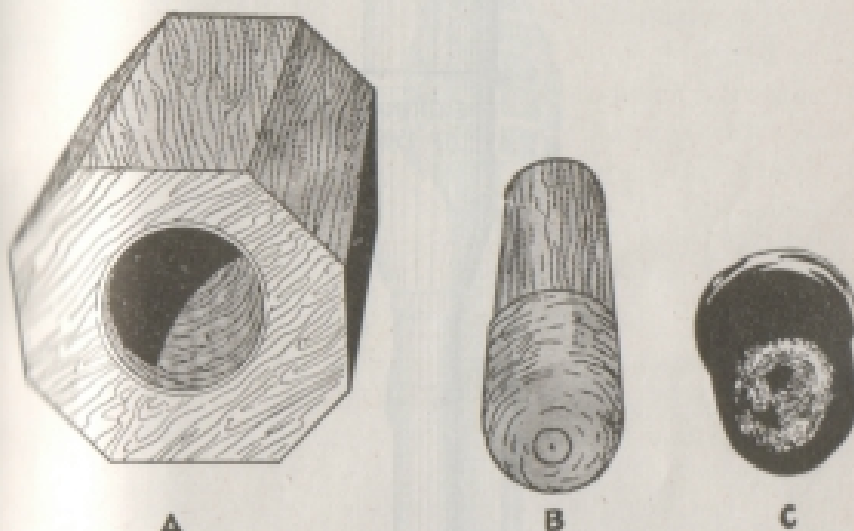
Figure 14. Nomenclature of antitank rifle grenades.

**c. Characteristics.** (1) PRACTICE ANTITANK RIFLE GRENADE M11A1. The design of this grenade is similar to that of the antitank rifle grenade M9A1. When damaged by repeated use the fin assembly or head may be replaced.

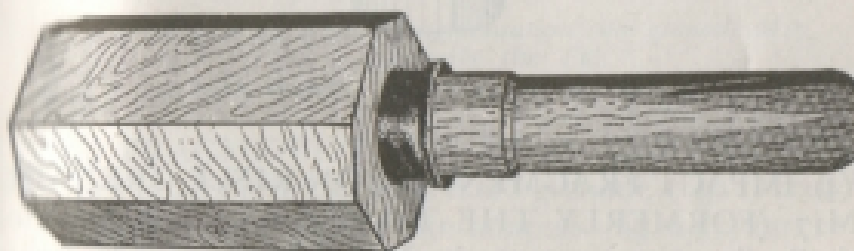
(2) PRACTICE ANTITANK RIFLE GRENADE M11A2. This inert grenade also is similar in shape and

weight to the MgAl grenade. It is designed to permit replacement of any part damaged by repeated use, and therefore consists of four parts: a cast body, a nose (ogive), a stabilized tube, and a fin. The service life of the nose may be increased by light maintenance work consisting of restoring crimps with a small riveting hammer or pair of pliers, and removal of dents by means of a hardwood die and punch made to the exterior and interior dimensions, respectively, of the nose (fig. 15).

*Figure 15. Repair of antitank rifle grenades.*

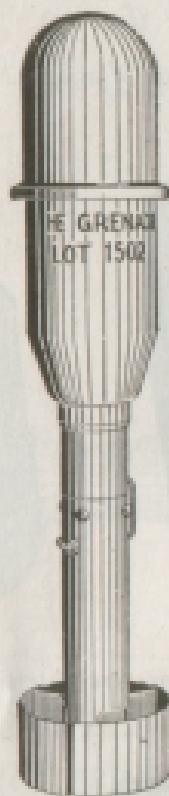


① *Punch and die used for straightening dented nose (ogive).  
A - Die, B - Punch, and C - Dented nose.*



② *Method of employing hardwood punch and die in straightening nose (ogive).*

(3) ANTITANK RIFLE GRENADE M9A1 (fig. 16). The grenade M9A1 has a sheet metal body and nose (ogive) and weighs 1.31 pounds. It has an impact type fuze and may detonate upon impact with soft earth. However, for certainty of detonation, it should strike the target head-on or nearly so.

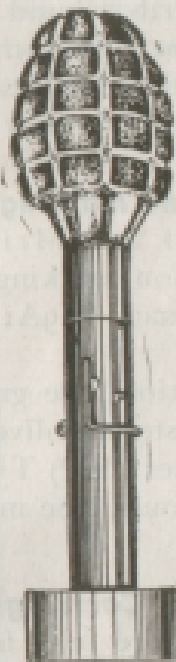


*Figure 16. Antitank rifle grenade M9A1.*

(4) IMPACT FRAGMENTATION RIFLE GRENADE M17 (FORMERLY THE T2) (fig. 17). This grenade is similar in appearance to the Mk. II hand grenade, has a serrated cast iron body, to which is fitted a fin assembly

16)  
nose  
type  
low  
target

composed of a stabilized tube and fin. Its maximum range is approximately 200 yards. An impact type fuze is located in the forward end of the stabilizer tube and explodes the grenade upon impact with ground of average hardness or any other solid object. Detonation will not occur upon impact with water, mud, or soft sand. The fuze is held in the unarmed position by a safety pin which fits in a hole through the fuze body and clamps about the stabilizer tube.



*Figure 17. Impact fragmentation rifle grenade M17  
(formerly the T2).*

GRADE  
nade,  
has a  
embly

(5) FRAGMENTATION HAND GRENADE MK. II WITH ADAPTER. This hand grenade (fig. 1) fired from the rifle with the aid of an adapter (fig. 23①) can be projected to ranges as great as 175 yards. The fuze becomes armed after the grenade and adapter leave the launcher.



When equipped with the M10A2 fuze, this grenade explodes at the expiration of from 4.3 to 5.5 seconds after the fuze becomes armed; with the M10A3 fuze, the delay is from 4.0 to 4.8 seconds.

(6) PRACTICE HAND GRENADE MK. II. For training purposes, this grenade may be used with the M1 adapter. This hand grenade contains a reduced charge (see par. 4a (2)).

(7) SMOKE RIFLE GRENADE (WP) T5. The T5 rifle grenade, similar in appearance to the M9A1 antitank rifle grenade, except for a rib around the body, is a bursting type smoke grenade containing white phosphorous. Upon impact, the grenade head bursts, scattering the phosphorous, which ignites spontaneously and burns, giving off a dense white smoke.

**d. Identification and markings.** (1) Practice antitank rifle grenades (M11A1 and M11A2) are painted black with white identification markings.

(2) Antitank rifle grenade M9A1 is painted a lusterless olive drab.

(3) Impact fragmentation rifle grenades M17 (formerly the T2) are painted lusterless olive drab.

(4) Smoke rifle grenades (WP) T5 are painted blue grey with a yellow band around the middle.

**30. ACCESSORIES. a. Cartridges** (fig. 18). (1) Special cartridges listed below are used for discharging all rifle grenades, both for antitank and antipersonnel use. *Neither ordinary blank ammunition nor service ammunition will be used.*

(a) *Rifle grenade cartridge, caliber .30, M3.* This cartridge is used in U.S. rifles M1, M1903, M1903A1, M1903A3, and M1917.

(b) *Carbine grenade cartridge, caliber .30, M6.* This cartridge is used in the U.S. carbine M1, M1A1, and M1A3.

(c) *Auxiliary grenade cartridge M7.* This cartridge, designed to give additional range when used in firing grenades from rifles and carbines, is a caliber .45 case draw piece loaded with 20 grains of powder and sealed with a paper wad. It is placed in the end of a launcher, a rim on the base of the case holding the cartridge in place. It functions only in combination with the standard M3 or M6 grenade cartridge and fits the M1, M2, M7, and M8 launchers. When using this cartridge the rifle or carbine will not be fired from the shoulder.

(g) *Ordinary temperatures do not affect these cartridges, but in extremes of cold or heat, shorts and overs result. It is necessary, therefore, to aim a little high in very cold weather and a little low in very hot weather in comparison with the normal sight picture.*

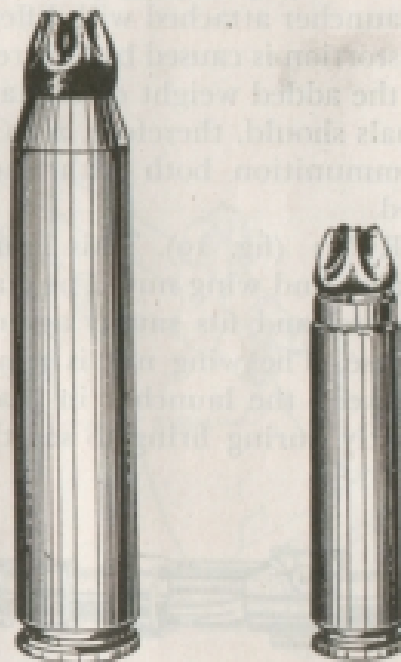


Figure 18. Cartridges for firing rifle grenades from rifle and carbine.

**b. Launchers.** (1) The launcher, on which the grenade is placed for firing, is an extension to the barrel of the rifle or carbine. A special device, integral with the launcher, attaches it securely to the muzzle of the weapon. If necessity demands, ball cartridges may be fired, even though the launcher is attached; however, the bayonet cannot be fixed. *Before firing ball cartridges, make certain that no grenade is on the launcher.*

(2) The classification of grenade launchers and the weapons with which they are used, are as follows:

- (a) Launcher M1 . . . U. S. rifles, caliber .30, M1903, M1903A1, and M1903A3.
- (b) Launcher M2 . . . U. S. rifle, caliber .30, M1917.
- (c) Launcher M7 . . . U. S. rifle, caliber .30, M1.
- (d) Launcher M8 . . . U. S. carbine, caliber .30, M1, M1A1, and M1A3.

(3) The zero of the rifle or carbine for firing ball ammunition with the launcher attached will differ from its normal zero. This distortion is caused by "barrel whip" which is occasioned by the added weight of the launcher on the muzzle. Individuals should, therefore, zero their weapons by firing ball ammunition both with and without the launcher attached.

(4) LAUNCHER M1 (fig. 19). This launcher is fitted with a hinged clamp and wing nut. The clamp folds over the top of the barrel and fits snugly against the rear of the front sight base. The wing nut is run down tightly on the clamp to keep the launcher in place. Check the wing nut frequently during firing to see that it is tight. (See par. 31.)

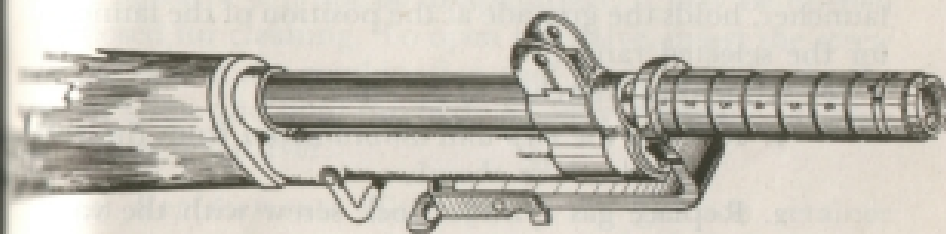


Figure 19. Launcher M1 attached to muzzle of rifle by clamp and wing nut.

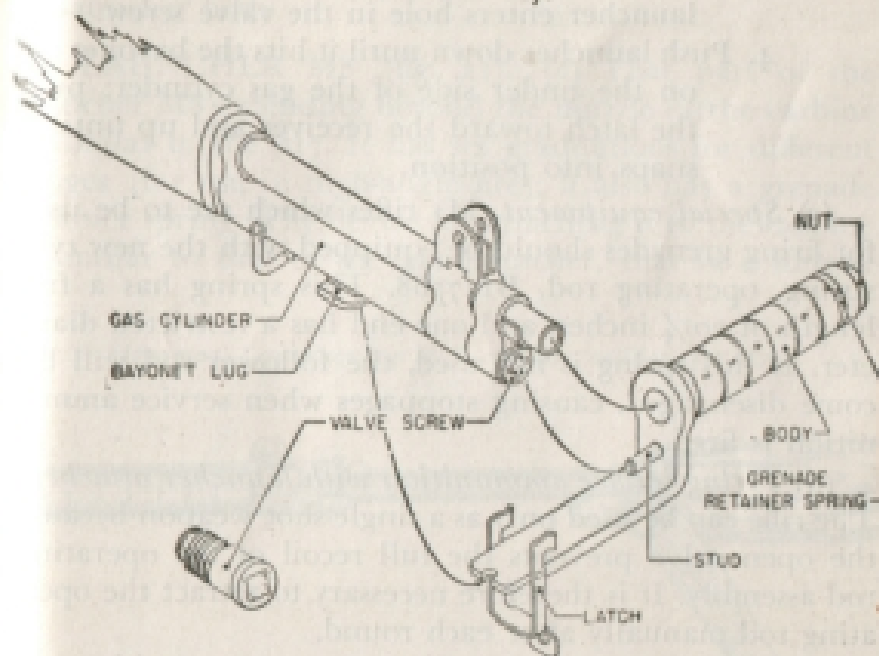
(5) LAUNCHER M2. This is the M1 launcher adapted for use with the M1917 rifle. When this launcher is not available, the M1 launcher may be used in its stead.

(6) LAUNCHER M7 (fig. 20). (a) Description. This launcher is secured to the M1 rifle by a latch which clamps

Figure 20. Launcher for U. S. rifle, caliber .30, M1.



© Launcher M7.



© Nomenclature of launcher M7.

in back of the bayonet lug. A valve screw, issued with the launcher, is substituted for the gas cylinder lock screw. A stud on the launcher protrudes into the valve screw when the launcher is attached, opening the valve and providing for enough gas release to avoid damage to recoiling parts. The valve remains open as long as the launcher is attached to the rifle. The launcher has six graduations for different ranges (for use in high angle fire). A grenade retainer spring, slightly larger in diameter than the launcher, holds the grenade at the position of the launcher for the selected range.

(b) Attaching launcher to M1 rifle.

1. Remove the *clip and ammunition* from the rifle and *clear the chamber*.
2. Replace gas cylinder lock screw with the valve screw.
3. Slip launcher over muzzle of rifle so that stud in launcher enters hole in the valve screw.
4. Push launcher down until it hits the bayonet lug on the under side of the gas cylinder; push the latch toward the receiver and up until it snaps into position.

(c) *Special equipment.* M1 rifles which are to be used for firing grenades should be equipped with the new type spring, operating rod, B147568. This spring has a free length of  $20\frac{1}{4}$  inches, and one end has a restricted diameter. If this spring is not used, the follower rod will become disengaged, causing stoppages when service ammunition is fired.

(d) *Firing service ammunition with launcher attached.* The rifle can be used only as a single-shot weapon because the open valve prevents the full recoil of the operating rod assembly. It is therefore necessary to retract the operating rod manually after each round.

(e) *Firing service ammunition after removal of launcher.* The rifle acts as a single-shot weapon for the first or

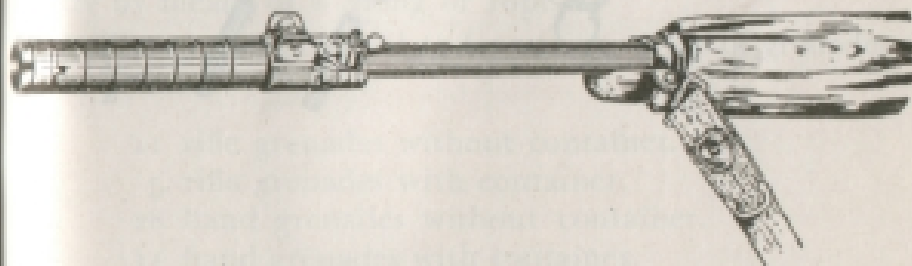
second round after removal. If the rifle does not function semiautomatically after the first two rounds have been fired, the valve screw should be removed and cleaned.

(f) *Cleaning.* The launcher may be cleaned with rifle bore cleaner. After cleansing, the surfaces are oiled with light preservative lubricating oil. The valve screw should be cleaned frequently by removing the carbon with a small brush or with a rag moistened with rifle bore cleaner. The valve will not be disassembled. It may be opened or closed for cleaning. To open the valve, insert the screw driver end of the combination tool in the opening in the valve screw and hold the body of the valve while pushing on the screw driver.

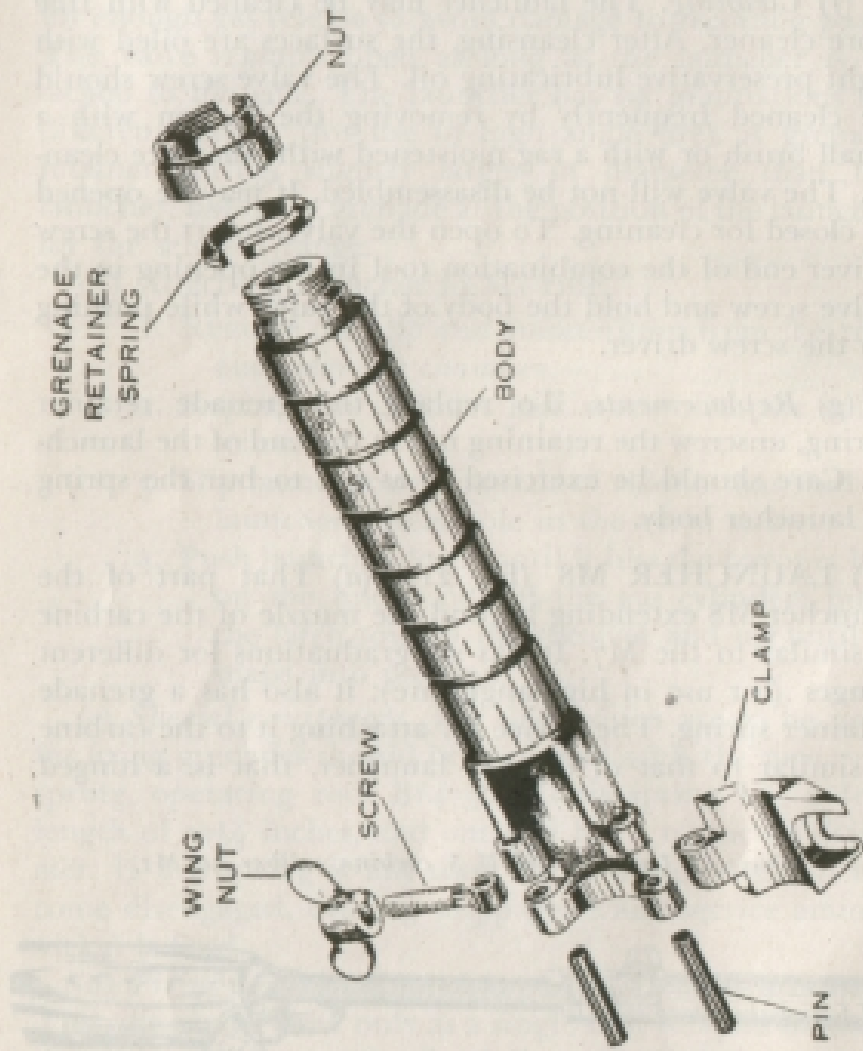
(g) *Replacements.* To replace the grenade retainer spring, unscrew the retaining nut at the end of the launcher. Care should be exercised so as not to burr the spring or launcher body.

(7) LAUNCHER M8 (fig. 21). (a) That part of the launcher M8 extending beyond the muzzle of the carbine is similar to the M7. It has six graduations for different ranges (for use in high-angle fire); it also has a grenade retainer spring. The device for attaching it to the carbine is similar to that of the M1 launcher, that is, a hinged

Figure 21. Launcher for U. S. carbine, caliber .30, M1.



© Launcher M8.



© Nomenclature of Launcher M8.

clamp and wing nut. After fastening the clamp by tightening the wing nut, check frequently thereafter, otherwise the launcher may slip forward during firing, and droop. (See par. 31.)

(b) The M8 launcher may be cleaned with rifle bore cleaner. After cleansing, the surfaces are oiled with light preservative lubricating oil.

**c. Launcher position clip.** To facilitate locating range positions on the launchers M1 and M2, when firing the grenade at high angles, position clips are furnished. They are packed with the impact fragmentation rifle grenade M17 (formerly the T2), the grenade projection adapter M1, and the smoke rifle grenade (WP) T5, as follows:

(1) Impact fragmentation rifle grenades M17.....	10
Position clips .....	3
(2) Grenade projection adapter M1 .....	48
Position clips .....	12
(3) Smoke rifle grenade (WP) T5 .....	10
Position clips .....	2

**d. Ammunition carrying bag** (fig. 22). (1) This is a durable and serviceable bag, easily stored when not in use, designed to carry grenades and other types of ammunition.

(2) It may be carried by means of either the hand or shoulder strap. It is equipped with two sets of D-rings to enable the soldier to secure the bag to the side of his body by means of a thong or rope.

(3) The capacity of the bag for various types of grenades is as follows:

- 11 rifle grenades without container.
- 5 rifle grenades with container.
- 28 hand grenades without container.
- 11 hand grenades with container.
- 11 hand grenades with projection adapters.



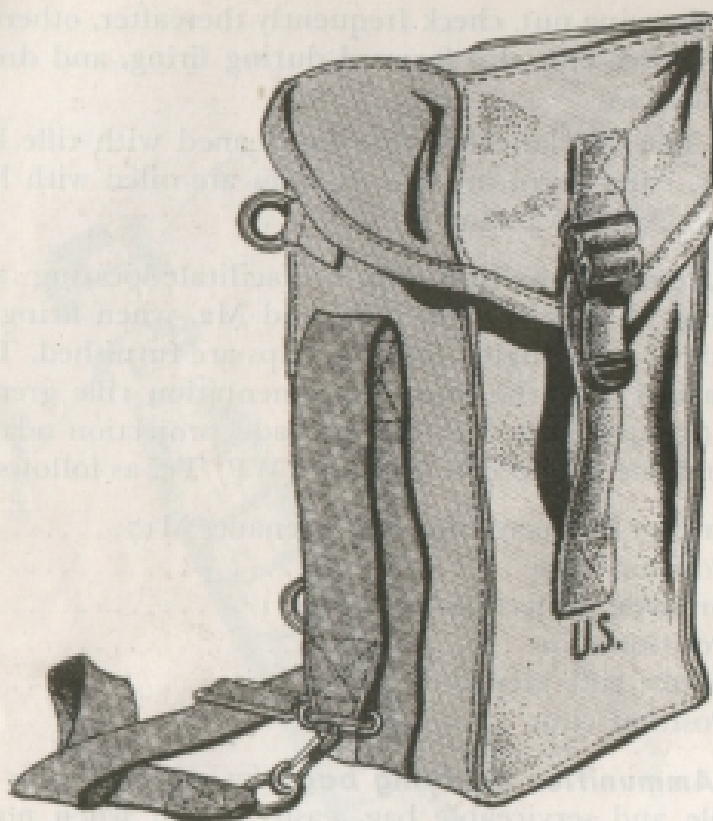
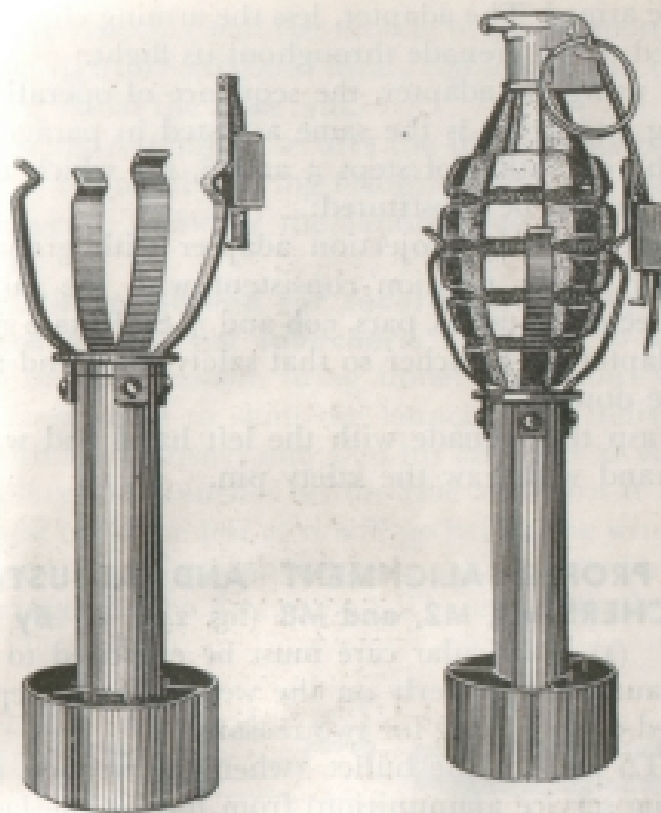


Figure 22. Ammunition carrying bag.

**e. Grenade-projection adapter M1** (fig. 23ⓐ and ⓑ). (1) The adapter consists of a stabilizer tube and a fin similar to those of the M9A1 grenade. Claws, attached to the stabilizer tube, grip the serrations of the hand grenade Mk. II. The long claw has an arming clip re- tainer and an arming clip.

(2) The adapter with grenade assembled, is fired in a manner similar to the firing of other rifle grenades. For training purposes the practice hand grenade Mk. II may be used with the adapter.



⊙ Grenade projection adapter M1.

⊙ Grenade projection adapter M1, with hand grenade Mk. II.

Figure 23. Method of converting hand grenade into rifle grenade.

(3) The grenade is mounted on the adapter by first inserting the grenade safety lever in the arming clip and then engaging the serrations with the claws; the arming clip is pushed to its most forward position and held there by friction. Upon firing, inertia causes the arming clip to remain stationary while the grenade and adapter are propelled forward. The arming clip straightens the bent-over portion of the arming clip retainer and slips from the claw and grenade safety lever, permitting the fuze to

become armed. The adapter, less the arming clip, remain attached to the grenade throughout its flight.

(4) In using the adapter, the sequence of operations for loading and firing is the same as listed in paragraph 3 with the exception of steps 5 and 6, for which the following should be substituted:

(5) Place grenade projection adapter with grenade on launcher in the position consistent with the range desired (see range tables, pars. 50b and 51c). Rotate grenade and adapter on launcher so that safety lever and arming clip are down.

(6) Grasp the grenade with the left hand and with the right hand withdraw the safety pin.

### **31. PROPER ALIGNMENT AND ADJUSTMENT LAUNCHERS M1, M2, and M8 (fig. 24). a. By use of shims.**

(1) Particular care must be exercised to adjust these launchers properly on the weapon and keep them adjusted during firing for two reasons:

(a) To prevent the bullet (when the weapon is used for firing service ammunition) from hitting the launcher on the inside of its bore and bulging it so that it is unfit for use.

(b) To insure accuracy when grenades are being fired

(2) When properly aligned, the axis of the bore of the launcher should be in exact prolongation of the axis of the bore of the rifle or carbine.

(3) The proper relationship between the launcher and the weapon may be determined by opening the bolt, and with the end of the launcher about 12 inches from the eye, sighting squarely down the bore. The two circles formed by the bore of the rifle or carbine must be concentric with the circle formed by the bore of the launcher (fig. 24). If this exact relationship does not exist, the launcher may be brought into proper alignment by putting shims (paper, cloth, or any other available material

align the launcher and the muzzle of the weapon (top or bottom, right or left), and firmly tightening the clamp by turning down the wing nut.

3. The wing nut which secures the hinged clamp must be checked frequently during firing; otherwise it may become loosened, allowing the launcher to slip forward and drop.

4. **Substitute method for securing accuracy when firing grenades from launchers.** In order to secure accuracy in rifle *grenade* firing under conditions which make it impossible to shim the launcher, an individual trained with the launcher may zero his *launcher* at various angles. Place the launcher on the rifle and turn it as far to the right or to the left as it will go before the wing nut is tightened. By firing *practice grenades* the zero for various key ranges is then determined. Thereafter, the launch-

MENT,  
e of  
ljust  
hem

used  
cher  
unfi  
ired.  
the  
is of

and  
and  
the  
rcles  
con-  
cher  
the  
put-  
rial)

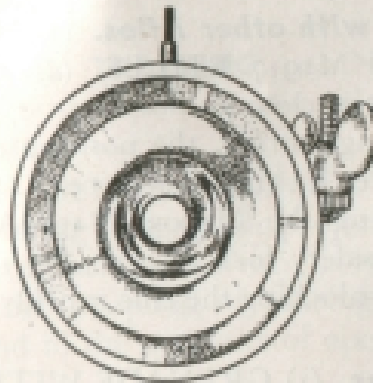
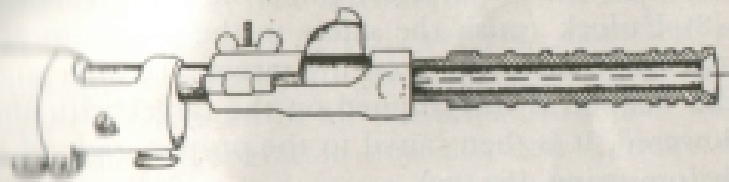


Figure 14. Method of aligning launchers M1, M2, and M8, with weapon.

er is always placed on the rifle in the same position and if necessary, the firer holds off to compensate for variation in the fit of his launcher.

**32. SEQUENCE OF OPERATIONS. a. U. S. rifle and carbine M1, M1A1, and M1A3.** In loading and firing, the following sequence must be observed:

- (1) Open the bolt and clear rifle.
- (2) Lock (push the safety to the safe position). (See below.)
- (3) Insert cartridge in chamber.
- (4) Close the bolt.
- (5) If the auxiliary grenade cartridge M7 is to be used for extra range, insert it in the launcher with the padlock toward the muzzle of the weapon.
- (6) Place grenade on launcher in a position dependent upon range desired in accordance with the range table.
- (7) Withdraw the safety pin from the grenade.
- (8) Unlock (push the safety to the fire position).
- (9) Align the weapon on the target. (In high-angle firing the weapon is first aligned on the target with the muzzle lowered. It is then raised to the proper angle of elevation before firing (fig. 39).
- (10) Fire the weapon.

**b. Sequence with other rifles.** (1) M1903, M1903A1, M1903A3, AND M1917 RIFLES. (a) The rifle will be locked after bolt is closed.

(b) In high-angle firing, the position clip is placed on the launcher after locking the piece.

(2) When locking the M1903, M1903A1, or M1903A3 rifles, raise the safety lock *only to the vertical position*. This facilitates unlocking the rifle quickly should occasion demand.

**c. Precautions.** (1) GRENADE WITH TIME FUSE. If the grenade should accidentally become armed after removal of the safety pin, unlock the weapon and

immediately, as the grenade will explode in 4 to 5 seconds. Care should be taken not to strike the lever after the safety pin is removed as such action may cause the lever to spring from the grenade and allow the fuze to function.

**3. GRENADE WITH IMPACT TYPE FUZE.** *Do not drop a grenade after the safety pin has been removed.*

*a.* If the weapon has previously been used to fire ball cartridges, care must be taken to see that none is fed into the chamber when the grenade is to be fired, as serious damage will result.

**d. Exercises in sequence of loading and firing.** (1) **PURPOSE.** To practice the proper sequence of loading and firing so as to acquire speed and accuracy in operation.

*a.* **METHODS.** The proper sequence is practiced in each position, the successive steps being performed initially "by the numbers." For all training in the sequence of loading and firing and in positions, the launcher is attached to and considered an integral part of the rifle. This training is repeated in all positions until each soldier can perform the operation smoothly and accurately, and is able to engage a target approaching from any direction.

**3. MECHANICAL TRAINING.** *a.* No training will be given in the construction or principles of functioning of the rifle grenades.

*b.* Individuals will be thoroughly trained in the proper method of assembling the grenade-projection adapter and grenade, of attaching the various types of launchers to the appropriate weapons, of placing the grenade on the launcher, and in the sequence of operations.

**4. SIGHTING AND AIMING.** *a.* There are now available several different grenades with varying ballistic qual-

ities which may be fired from several weapons with different front and rear sights. This situation has necessitated the development of a universal sighting device for ready attachment to each weapon which will furnish an accurate *angular* measurement of elevation when firing rifle grenades.

**b.** The grenade launcher sight T59 (fig. 25) can be installed on the stock of caliber .30 rifles M1, M190, M1903A1, M1903A3, M1917, and on caliber .30 carbines M1, M1A1, and M1A3. It consists of a mounting plate which is fastened to the left side of the stock by two special wood screws, and a sight bar assembly which snaps on the mounting plate. The mounting plate is calibrated in 5° intervals from 0° to 45° elevation and is numbered in 10° intervals. A 60° calibration is also marked. The sight bar assembly consists of a 5-inch sight bar having an open sight and a level vial for use in low-angle and high-angle fire, respectively. Provision is made for both vertical and horizontal adjustments of the sight to zero the weapon.

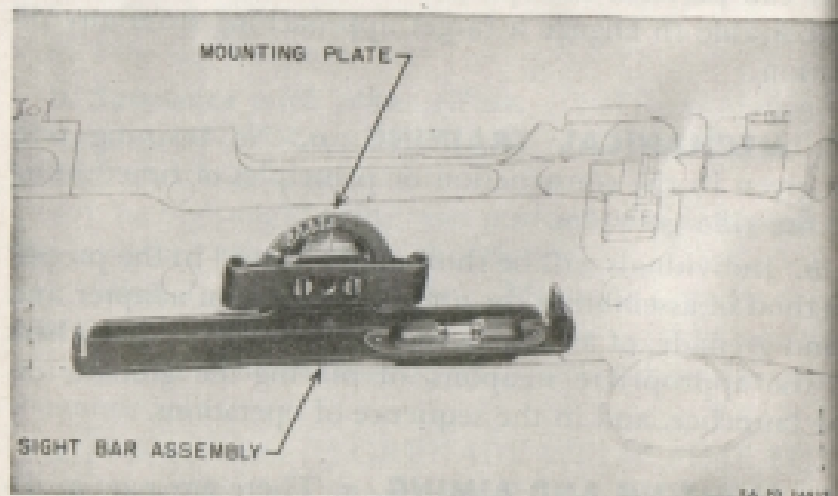


Figure 25. Grenade Launcher Sight T59.

b. Pending the issuance of the T59 or similar sight the angles of elevation shown in the range tables must be estimated by the firer.

d. The method of sighting and aiming the M1903 and M1903A1 rifles with M9A1 grenade given in paragraph 27 will continue in use for the present.

## SECTION II

### ANTITANK MARKSMANSHIP

**28. GENERAL. a. Purpose.** The purpose of this section is to provide a thorough and uniform method of training individuals to fire the antitank grenade at stationary and moving targets.

**b. Place in training.** (1) Training in antitank grenade firing should follow the course in rifle marksmanship. Without proper training in rifle marksmanship, the soldier instinctively gives the trigger a sudden pressure which results in flinching. The added weight of the launcher and the grenade exaggerates this tendency.

(2) The methods of instruction are similar to those used in teaching marksmanship with any other weapon. Training is divided into steps which must be taught in proper sequence.

**c. Fundamentals.** To become proficient in firing the grenade, a soldier must be trained in the following essentials:

- (1) Correct sighting and aiming.
- (2) Correct positions.
- (3) Correct trigger squeeze.
- (4) Correct sequence of operations in loading and firing.
- (5) Correct range estimation.
- (6) Correct application of leads for moving targets.



**36. EQUIPMENT. a.** The equipment required for preparatory training is as follows:

U. S. rifle, caliber .30, M1903, M1903A1, and M1903A3.

Grenade launcher M1.

Grenade launcher sight T59, or similar sight, when available.

Practice grenades, M11A1 or M11A2.

Rifle rest.

6- by 6-foot target frame.

20-inch sighting disk.

**b.** The following additional equipment is required:

(1) For U. S. rifle, caliber .30, M1917—

Grenade launcher M2. (The grenade launcher M1 may be used if the M2 launcher is not available.)

(2) For U. S. rifle, caliber .30, M1—

Grenade launcher M7.

(3) For U. S. carbine, caliber .30, M1, M1A1 or M1A3—

Grenade launcher M8.

**c.** Rifle rest, target frames, and sighting disks are readily improvised.

### **37. SIGHTING AND AIMING M9A1, M11A1, OR M11A2 GRENADES, M1903 OR M1903A1 RIFLES.**

**a. Sight setting.** The peep sight is set at 2,200 yards (fig. 26).

**b. Method of aiming.** (1) Use the top of the grenade as a front sight (fig. 27) and for a range of—

(a) 25 yards.

1. Use range marking 1,875 on the sight leaf, or—

2. Use open sight just above peep sight, aiming 12 inches below point it is desired to strike.

(b) 37.5 yards. Use the open sight just over the peep sight.

(c) 50 yards. Use the top of the drift slide.

(2) For a range of 75 yards, use the *top* of the front sight

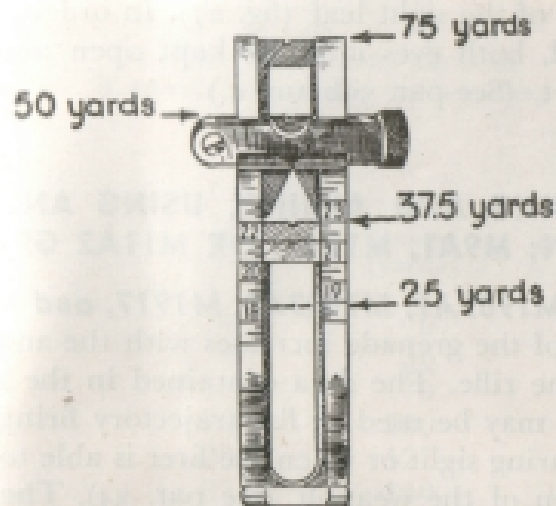


Figure 26. Rear sight leaf M1903 and M1903A1 rifles, set for use with grenades M9A1, M11A1, and M11A2.

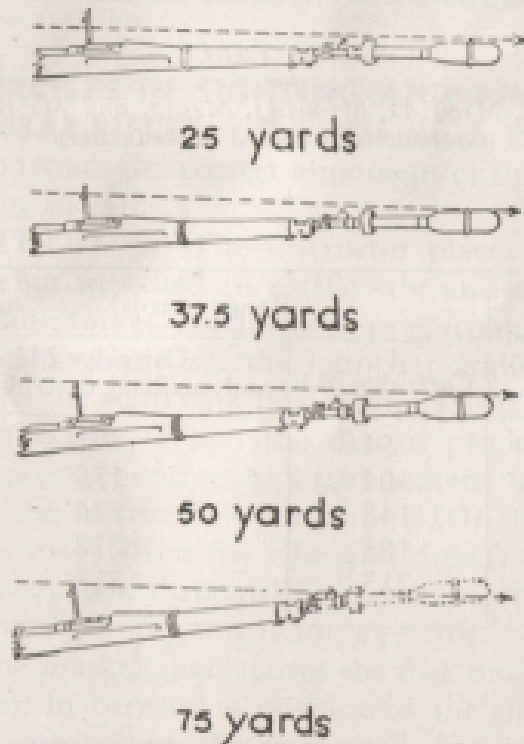


Figure 27. Method of aiming grenades M9A1, M11A1, and M11A2, with M1903 and M1903A1 rifles.

and the *top* of the sight leaf (fig. 27). In order to employ this method, both eyes must be kept open and focused on the target. (See par. 39b and c.)

### 38. SIGHTING AND AIMING, USING ANGLES OF ELEVATION; M9A1, M11A1, OR M11A2 GRENADES

#### a. M1903, M1903A1, M1903A3, M1917, and M1 rifles

The range of the grenade increases with the angle of elevation of the rifle. The data contained in the following range table may be used in flat trajectory firing with an angle-measuring sight or when the firer is able to estimate the elevation of the weapon (see par. 34). The grenade should be fully seated on the launcher.

#### RANGE TABLE

for  
M1903, M1903A1, M1903A3, M1917, and M1 rifles  
(Grenade fully seated on launcher)

Elevation (degrees)	Range (yards)	
	Cartridge M3	Cartridge M3 and auxiliary cartridge M7
5	54	91
10	104	175
15	148	226
20	185	278
25	215	315

b. M1, M1A1, and M1A3 Carbines. The following range table applies to these weapons:

*RANGE TABLE*  
for  
*M1, M1A1, and M1A3 Carbines*  
(Grenade fully seated on launcher)

Elevation (degrees)	Range (yards)
0	0
5	36
10	70
15	100
20	127
25	149

NOTE: Range data for auxiliary grenade cartridge will be published when available.

**39. EXERCISES IN SIGHTING AND AIMING, M1903 OR M1903A1 RIFLES. a. Exercise No. 1. (1) PURPOSE.**

To demonstrate the correct alignment of sights for ranges from 25 to 50 yards.

(2) METHOD. (a) The instructor places the rifle with the launcher attached in a rifle rest and aligns the rest with a blank target. An antitank practice grenade M11A1 or M11A2 is placed on the launcher and the instructor then aligns the sight disk by directions to the marker who controls the disk. When the disk is properly placed to demonstrate the correct sight alignment for a range of 25 yards, the instructor commands: HOLD. The instructor moves away from the rifle and directs each pupil in his group to look through the sights in order to observe the correct sight alignment for 25 yards.

(b) The marker then moves the disk out of alignment. Each pupil in turn takes position at the rifle and directs the marker to move the disk until the sight alignment is correct for a range of 25 yards. The coach verifies the

alignment for each pupil. The exercise is repeated to demonstrate the correct sight alignment for ranges of 37.5 and 50 yards.

**b. Exercise No. 2.** (1) **PURPOSE.** To demonstrate the method of sight alignment for a range of 75 yards.

(2) **METHOD.** The instructor demonstrates the technique of aligning the sights with both eyes open, by having each student close his left eye and hold one or more fingers in front of his right eye so as to obscure the sighting disk, and then having the pupil open the left eye. With both eyes open the disk again is visible.

**c. Exercise No. 3.** (1) **PURPOSE.** To demonstrate the correct sight alignment for a range of 75 yards.

(2) **METHOD.** The instructor repeats exercise No. 1 with the disk aligned correctly for a range of 75 yards.

**40. POSITIONS. a. General.** (1) The antitank rifle grenade may be fired from any position used for firing a rifle except squatting and sitting.

(2) When firing from the shoulder, care must be exercised to seat the butt of the rifle firmly against the shoulder.

(3) Do not fire from the shoulder when in the *prone* position; nor from the shoulder in any position that does not permit the body to move with the recoil of the rifle. A butt rest should be used for firing from the prone position.

(4) Owing to the height of the sight, the cheek cannot be pressed firmly against the stock. Consequently the head must be held well away from the rifle. This also prevents injury to the cheek from the recoil.

(5) In firing from any position, the left hand should be held several inches back from the sling swivel to eliminate any possibility of pinching the hand or fingers. The sling is not used in flat trajectory firing of rifle grenades.

**b. Standing** (fig. 28). The body should be faced at an angle from  $60^{\circ}$  to  $70^{\circ}$  from the line of fire with feet spread

about a foot apart. Body should be well forward, leaning into the piece, left knee slightly bent, right leg straight.

2. **Knocking** (fig. 29). The firer kneels on the right knee, half-faced to the right, the left knee bent so that the lower leg is vertical (as seen from the front); left arm well under the rifle and free from the left knee; right elbow above or at the height of the right shoulder; the body well forward so as not to be sitting on the right heel.

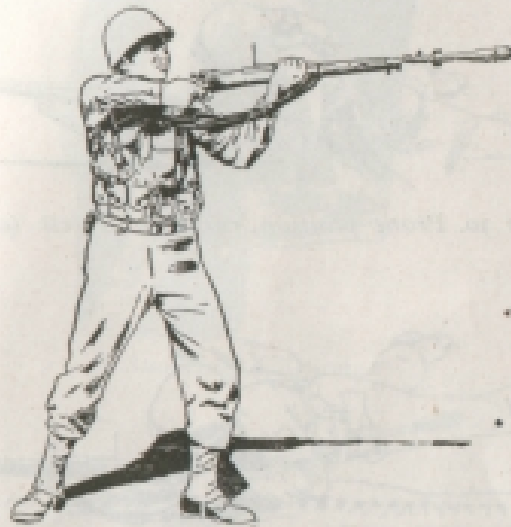


Figure 28. Standing position.



Figure 29. Kneeling position.

**d. Prone with casual butt rest** (figs. 30 and 31). In field firing, when firing from the prone position, any butt rest of which the firer may avail himself quickly (stump, vehicle rut, or other indentation in the ground) should be utilized. The right forearm is placed over the top of the butt of the rifle in order to hold it in firing position.

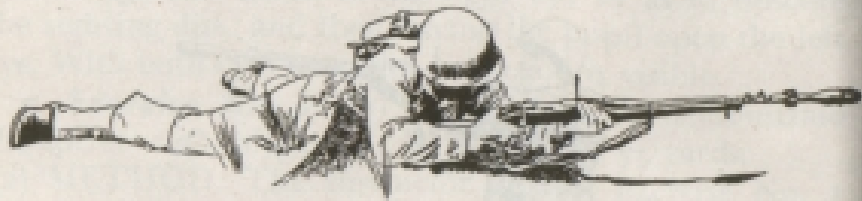


Figure 30. Prone position, casual butt rest (stump).

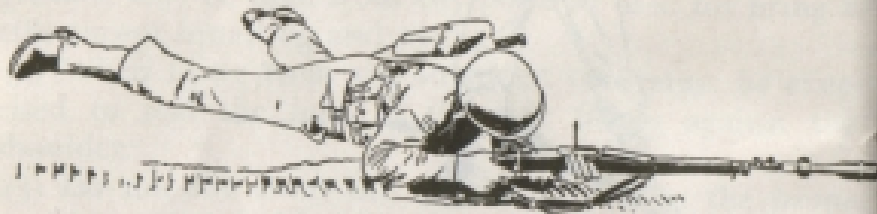
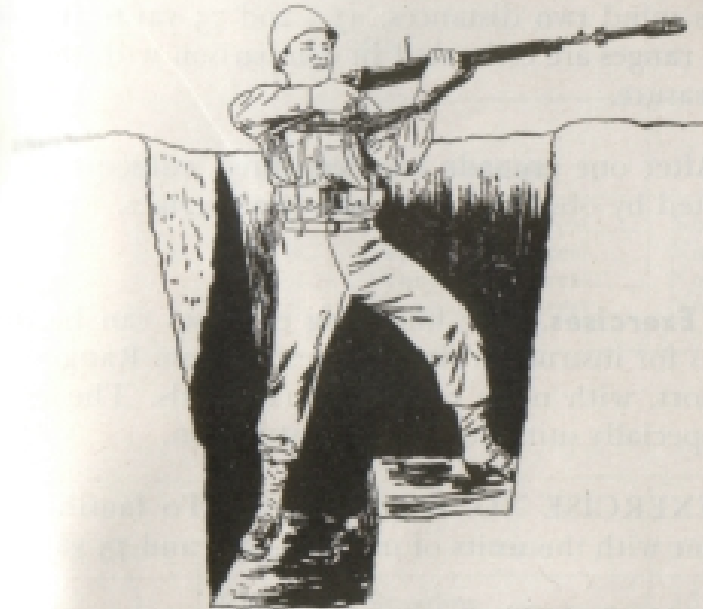


Figure 31. Prone position, casual butt rest (wheel rut).

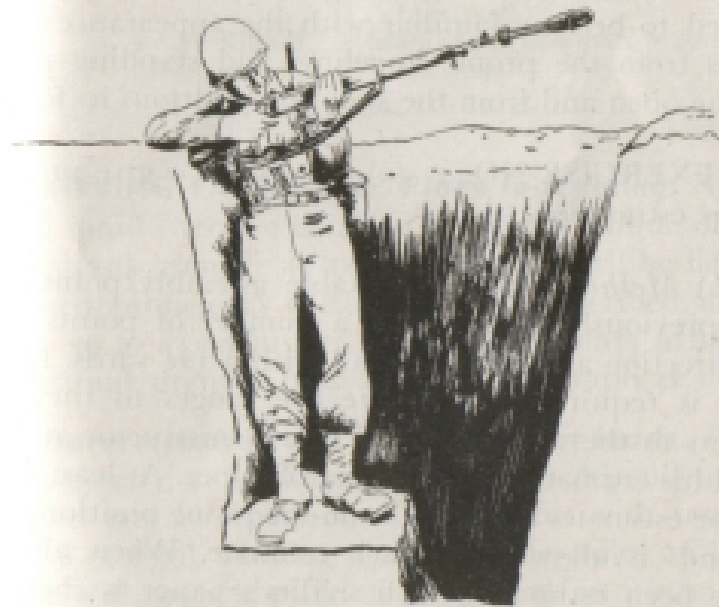
**e. From fox hole** (fig. 32ⓐ and ⓑ). In field firing, the soldier should fire from a standing type one-man fox hole. When the nature of the target permits, he should use the backwall of the fox hole as a butt rest.

**41. RANGE ESTIMATION. a. General.** (1) The firer must be well trained in hasty range estimation and its application to marksmanship. Because the weapon is normally employed quickly and at short ranges, the firer must estimate ranges by eye or by observation of fire.

Figure 30. Firing from standing type one-man foxhole.



Ⓒ Standing position.



Ⓒ Using backwall as butt rest.



(2) The usual method of range estimation is by eye. The firer is taught to estimate accurately and fix permanently in his mind two distances, 37.5 and 75 yards. Targets at other ranges are estimated in comparison with these units of measure.

(3) After one grenade has been fired, subsequent fire is adjusted by observation of successive strikes.

**b. Exercises.** The following exercises can be used as guides for instruction in range estimation. Ranges should be short, with none exceeding 125 yards. The exercises are especially suitable for class instruction.

(1) EXERCISE NO. 1. (a) *Purpose.* To familiarize the student with the units of measure, 37.5 and 75 yards.

(b) *Method.* The units of measure, 37.5 yards and 75 yards, are staked out on the ground. All students are required to become familiar with the appearance of these units from the prone, kneeling, and standing positions in the open and from the standing positions in fox holes.

(2) EXERCISE NO. 2. (a) *Purpose.* To give practice in range estimation.

(b) *Method.* From a suitable assembly point, ranges are previously measured to a number of points varying in direction and range but all within 125 yards. Each soldier is required to estimate the ranges to the various points as they are indicated by the instructor and to record his estimations on a sheet of paper. At least one-half of the estimates are made from the prone position. Thirty seconds is allowed for each estimate. When all ranges have been estimated, each soldier's paper is checked by the instructor and the true ranges are announced.

**42. STATIONARY TARGET COURSE.** The following is a suggested course for firing at stationary targets.

TABLE I

Range (yards)	Shots	Target	Position	Time
25	1	Rifle B...	Prone, casual rest....	No limit.
37½	1	Rifle B...	Prone, casual rest....	No limit. *
50	1	Rifle B...	Prone, casual rest....	No limit.
75	1	Rifle B...	Prone, casual rest....	No limit.

TABLE II

Range (yards)	Shots	Target	Position	Time
25	1	Rifle B...	Standing.....	15 seconds.
37½	1	Rifle B...	Kneeling.....	15 seconds.
50	1	Rifle B...	Prone, with casual butt rest.	15 seconds.
75	1	Rifle B...	Standing in one-man fox hole.	20 seconds.

**43. MOVING TARGETS. a. Place in training.** No individual should receive training in the technique of firing the antitank grenade at moving targets until he has demonstrated proficiency in the training prescribed in paragraphs 39 to 41 inclusive, and the stationary firing with the antitank grenade prescribed in paragraph 42.

**b. Determination and application of leads.** (1) The lead necessary to hit a moving target is dependent upon its speed and its direction of movement with respect to the line of sight. Moving at speed of 15 miles an hour, a vehicle will cover approximately 7 yards in 1 second—the average length of a medium tank. The antitank grenade

moves 25 yards in approximately  $\frac{1}{2}$  second and 50 yards in  $1\frac{1}{4}$  seconds. Therefore, to hit a vehicle moving across the front at 15 miles an hour at ranges of 25 and 50 yards, the leads should be about  $3\frac{1}{2}$  and 8 yards, respectively. At a speed of 25 miles an hour, the leads should be about 6 and 15 yards, respectively.

(2) Leads are applied by using the length of the target as it appears to the firer as a unit of measure. This eliminates the necessity for corrections due to the angle at which the target crosses the line of sight because the more acute the angle the smaller the target appears and the less lateral speed it attains.

(3) The following table of leads is furnished as a guide:

Target moving at right angle to line of fire (mph)	Leads at ranges of—	
	25 yards	50 yards
15.....	$\frac{1}{2}$	1
25.....	1	2

**c. Technique of fire** (1) **APPROACHING TARGETS.** For a range of 25 yards, aim at the point it is desired to hit. For a range of 50 yards, aim 1 foot below the point it is desired to hit.

(2) **RECEDING TARGETS.** For a range of 25 yards, aim approximately 1 foot above the point it is desired to hit. For a range of 50 yards, aim about 5 feet above the point it is desired to hit.

(3) **CROSSING TARGETS.** Align sights at the point it is desired to hit and, by rotating the body at the hips, swing the rifle across in the direction of the movement of the target to the desired lead. The rifle is kept swinging and the shot is squeezed off as the proper lead is reached.

**d. Preparatory exercises.** (1) In order to familiarize the individual with different target speeds, the instructor has the target towed at 15 and 25 miles per hour—

- (a) Across the front, at 37.5 and 75 yards range.
- (b) Toward the firer, from 100 to 25 yards.
- (c) Away from the firer, from 25 to 100 yards.

(2) Coaches, previously trained, illustrate the method of picking up the target, swinging through, and securing the correct lead for each range and speed. Throughout these exercises, the instructor reviews the technique described in **b** and **c** above.

**44. MOVING TARGET COURSE.** The following is a suggested course for firing at moving targets:

*COURSE TO BE FIRED*

Range (yards)	Number of rounds, M11A1 or M11A2	Position	Direction of movement of target	Speed (mph)
25	2	Kneeling in shell crater or other depression.	Across front	15
50	2	Standing in fox hole...	Across front	25
50 to 25	2	Kneeling in shell crater or other depression.	Approaching	15
75 to 50	2	Standing in fox hole...	Approaching	25
25 to 75	2	Standing in fox hole...	Receding...	15

**45. FIRING AT FIELD TARGETS. a. Purpose.** The purpose of this phase of training is to develop aptitude in the individual in the handling of his weapon under simulated battlefield conditions.

**b. Extent.** The extent of this training is limited only by available time and ammunition allowances. Care in use of the practice grenades and their efficient mainte-

nance when damaged will greatly extend their period of usability.

**c. Prior training.** Before receiving training in firing at field targets, each individual should have demonstrated proficiency in the firing suggested in paragraphs 42 and 44.

**d. Exercises.** (1) Standing type one-man fox holes having been dug at suitable points on the antitank moving target range, as suggested in paragraph 46b (4), targets are operated at varying speeds and time intervals so as to provide surprise targets crossing, approaching, and receding at various angles. The firer is required to select the position to be used and the proper time and method of engagement of the target.

(2) In addition to the firing exercises on the antitank range, advantage should be taken of every opportunity to combine training in antitank grenade firing with field exercises.

**46. EQUIPMENT, RANGES, AND PRECAUTIONS. a. Targets** (figs. 33 and 34). (1) For stationary target firing, a standard 6- by 6-foot target frame, covered with target

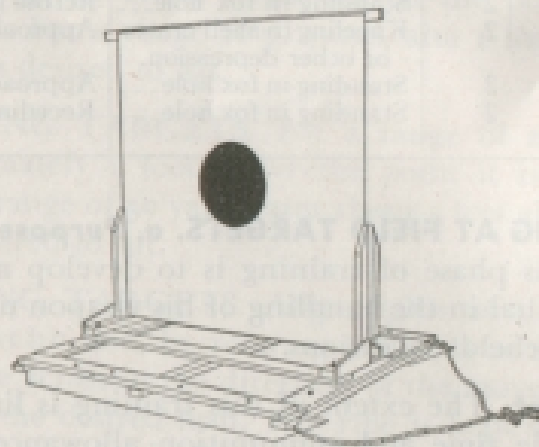


Figure 33. Sled for moving target.

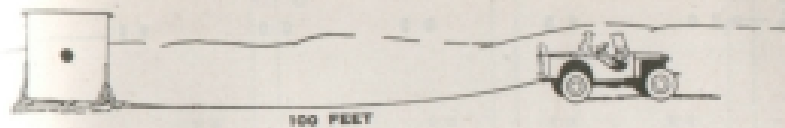


Figure 34. Manner of towing targets.

cloth, burlap, or other light material, should be used. A 20-inch bull's-eye should be painted or a target repair center (B-C) pasted thereon. A sandbag tank silhouette is also suitable for a target.

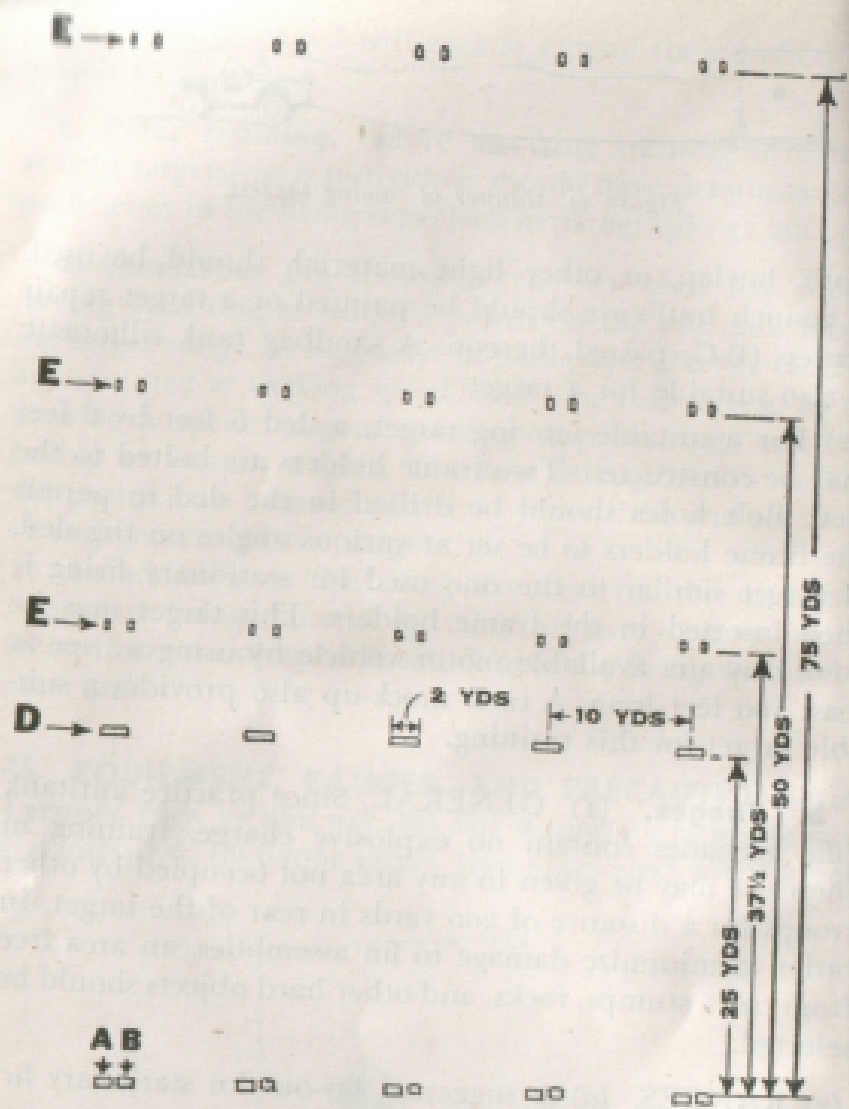
(2) For a suitable moving target, a sled 6 feet by 6 feet may be constructed. Two frame holders are bolted to the sled. Bolt holes should be drilled in the sled to permit the frame holders to be set at various angles on the sled. A target similar to the one used for stationary firing is then inserted in the frame holders. This target may be towed by any available motor vehicle by using a rope at least 100 feet long. A tank mock-up also provides a suitable target for this training.

**b. Ranges.** (1) **GENERAL.** Since practice antitank rifle grenades contain no explosive charge, training in their use may be given in any area not occupied by other troops for a distance of 200 yards in rear of the target. In order to minimize damage to fin assemblies, an area free from trees, stumps, rocks, and other hard objects should be selected.

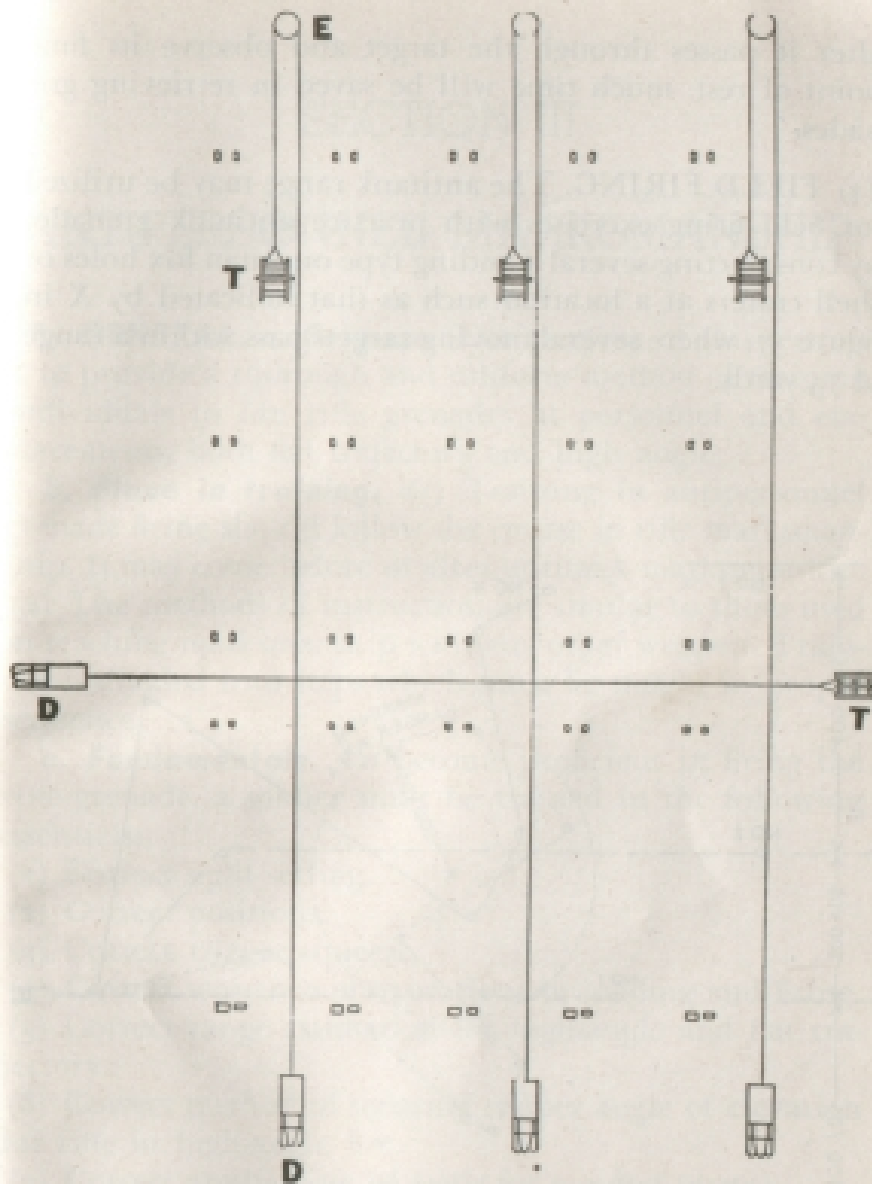
(2) **RANGES.** (a) A suggested lay-out for stationary firing is shown in figure 35.

(b) A suggested lay-out for moving-target firing is shown in figure 36.

(3) **RETRIEVING GRENADES.** Since the firer can see the grenade in flight and striking the target, it is not necessary to cease firing and check targets after each shot. If one man is detailed to watch the flight of each grenade



- A - Shell crater.
  - B - Standing type one-man fox hole.
  - D - Standard 6- by 6-foot target frame.
  - E - Boxes set in ground to hold sides of targets.
- Figure 35. Lay-out for stationary firing range.



D - Towing truck.  
 E - Ground pulley.  
 T - Target on sled.

*For firing at crossing targets, one target may be towed along the front of the entire firing point, each individual firing at the target in succession and observing the strike of his own grenade. For firing at approaching and receding targets, a target will be necessary for each two firing points.*

Figure 36. Lay-out for moving-target firing.



after it passes through the target and observe its final point of rest, much time will be saved in retrieving grenades.

(4) FIELD FIRING. The antitank range may be utilized for field firing exercises with practice antitank grenades by constructing several standing type one-man fox holes or shell craters at a location such as that indicated by X in figure 37, where several moving targets pass within a range of 75 yards.

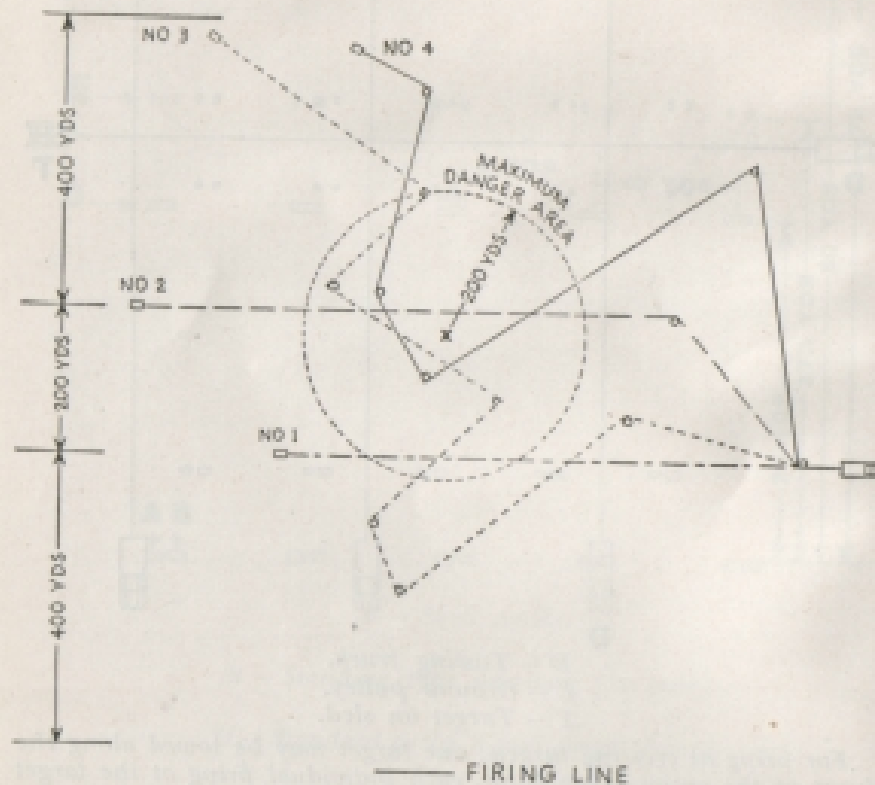


Figure 37. Employment of antitank range for antitank practice grenade field firing.

## SECTION III

### ANTIPERSONNEL MARKSMANSHIP

**47. GENERAL. a. Purpose.** The purpose of this section is to provide a thorough and uniform method of training individuals to fire rifle grenades at personnel and emplacements, both flat trajectory and high angle.

**b. Place in training.** (1) Training in antipersonnel grenade firing should follow the course in rifle marksmanship. It may come before or after antitank marksmanship.

(2) The methods of instruction are similar to those used in teaching marksmanship with any other weapon. Training is divided into steps which must be taught in proper sequence.

**c. Fundamentals.** To become proficient in firing the rifle grenade, a soldier must be trained in the following essentials:

- (1) Correct sight setting.
- (2) Correct positions.
- (3) Correct trigger squeeze.
- (4) Correct sequence of operations in loading and firing.
- (5) Correct range estimation for high-angle and flat trajectory.
- (6) Correct method of securing proper angle of elevation for rifle in high-angle fire.
- (7) Correct application of leads for moving targets.

**48. EQUIPMENT. a.** The equipment required for preparatory training is as follows:

- U. S. rifle, caliber .30, M1903, M1903A1, or M1903A3.
- Grenade launcher M1.

Grenade launcher sight T59, or similar sight, when available.

Grenade-projection adapter M1.

Practice hand grenade Mk. II.

Fragmentation hand grenade Mk. II.

Impact fragmentation rifle grenade M17 (formerly the T2).

Position clip (for high-angle fire).

Rifle rest.

Vertical target (for flat trajectory fire) (see par. 11).

Silhouette targets (for high-angle fire).

20-inch sighting disk.

**b.** The following additional equipment is required:

(1) For U. S. rifle, caliber .30, M1917—

Grenade launcher M2. (The M1 grenade launcher may be used if the M2 launcher is not available.)

(2) For U. S. rifle, caliber .30, M1—

Grenade launcher M7.

(3) For U. S. carbine, caliber .30, M1, M1A1, or M1A3—

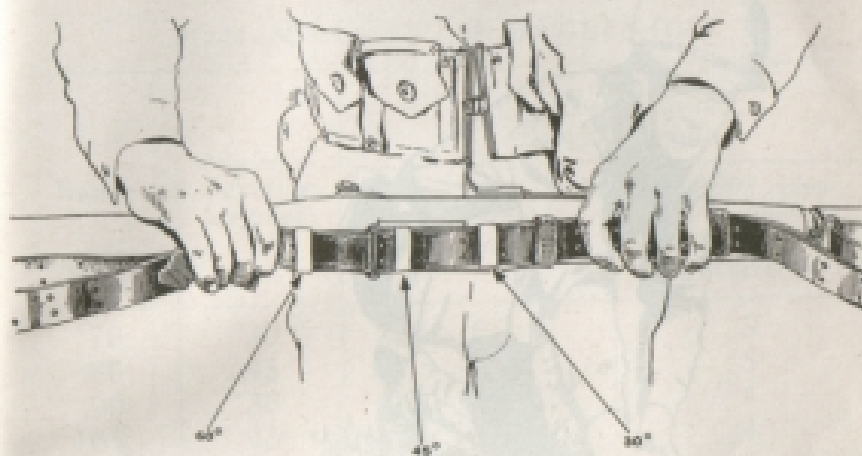
Grenade launcher M8.

#### **49. SIGHTING AND AIMING, HIGH-ANGLE FIRE. a.**

**Factors determining range.** In employing high-angle fire,  $30^{\circ}$ ,  $45^{\circ}$ , and  $60^{\circ}$  angles of elevation are used in combination with exposure of a fixed number of rings on the launcher for each range (par. 50). *Rule: The greater the number of rings exposed, the shorter the range.* In the case of the fragmentation hand grenade with adapter, the use of the  $30^{\circ}$  and  $60^{\circ}$  angles enables the firer to secure the desired range, yet keep the time of flight within the limits of the burning time of the fuze, thus securing ground bursts (see table, par. 50b).

**b. Method of marking sling** (fig. 38). Loosen the lower loop of the sling. Place the left foot on the sling. Raise the rifle (or carbine) until the sling is taut. By using a clinometer, determine and mark the point at

which the sling held perpendicularly, touches the ground for the three launcher angles, that is,  $30^\circ$ ,  $45^\circ$  and  $60^\circ$ . Mark sling with wide strips of adhesive tape.



*Figure 38. Manner of marking sling for angles.*

**c. Use of marked sling in firing.** (fig. 39). With butt of the piece on the ground, the muzzle is raised sufficiently so that firer may align the grenade on the launcher with the target. The left foot is placed on the sling at the correct mark for the angle desired, and the piece is then raised to the proper angle of elevation. In the firing position, the foot should be directly beneath the stock ferrule swivel (in the case of the carbine, directly beneath the front band).

**50. RANGE TABLES, HIGH-ANGLE FIRE.** The following are the range tables to be used with the M9A1, M11A1, and M11A2 grenades; the fragmentation hand grenade Mk. II, with grenade projection adapter M1; the impact fragmentation grenade M17 (formerly the T2) and the smoke grenade T5.

Figure 39. Antipersonnel fire (high angle).



Ⓐ Method of determining direction.



Ⓑ Securing angle of elevation.

**a. Range tables for M9A1, M11A1, and M11A2 grenades. (1) WITH M1 RIFLE (M7 LAUNCHER), M1903 RIFLES (M1 LAUNCHER), AND M1917 RIFLE (M2 LAUNCHER).**

*M9A1, M11A1, AND M11A2 GRENADES*

Range	Angles of elevation (degrees)	Launcher position (Rings exposed)	
		M1 rifle (M7 launcher)	M1903 rifles (M1 launcher) or M1917 rifle (M2 launcher)
70	30	6	5
80	45	6	5
90	30	5	4
105	45	5	4
120	30	4	3
135	45	4	3
150	30	3	2
165	45	3	2
180	30	2	1
200	45	2	1
210	30	1	-----
230	45	1	-----
255	45	None	None
365	45	None plus auxiliary cartridge M7	None plus auxiliary cartridge M7

(2) WITH M1 CARBINES (M8 LAUNCHER).

*M9A1, M11A1, AND M11A2 GRENADES  
M1 CARBINES*

Range	Angles of elevation (degrees)	Launcher position (rings exposed)
50	30	6
55	45	6
70	30	5
80	45	5
95	30	4
110	45	4
115	30	3
130	45	3
135	30	2
150	45	2
170	45	1
185	45	None
235	45	None plus auxiliary cartridge M7

**b. Range tables for fragmentation hand grenade Mk. II with grenade projection adapter M1.** The extremes of burning time of the M10A2 and M10A3 fuzes, with which this grenade is equipped, are 4 seconds and 5½ seconds. It is desirable to secure ground bursts. To assist the firer in determining what angle of elevation and what launcher position to use, to obtain this result, the time of flight of the grenade is included in the range table.

(1) WITH M1 RIFLE (M7 LAUNCHER), M1903 RIFLES (M1 LAUNCHER), AND M1917 RIFLE (M2 LAUNCHER).

*FRAGMENTATION HAND GRENADE MK. II,  
WITH PROJECTION ADAPTER*

Range	Angles of elevation (degrees)	Launcher position (rings exposed)		Time of flight (seconds)
		M1 rifle (M7 launcher)	M1903 rifles (M1 launcher) or M1917 rifle (M2 launcher)	
50	60	6	5	4.1
70	60	5	4	4.8
80	45	5	4	4.0
105	45	4	3	4.6
130	45	3	2	5.1
140	30	2	1	4.0
165	30	1	-----	4.4
180	30	None	None	4.6
225	30	None	None	Note
		plus auxiliary cartridge M7	plus auxiliary cartridge M7	

NOTE: Complete range data for auxiliary grenade cartridge will be published when available.



(2) WITH M<sub>1</sub> CARBINES (M8 LAUNCHER).

FRAGMENTATION HAND GRENADE MK. II,  
WITH PROJECTION ADAPTER  
M<sub>1</sub> CARBINES

Range	Angles of elevation (degrees)	Launcher position (rings exposed)	Time of flight (seconds)
45	60	5	3.8
55	60	4	4.4
70	60	3	4.9
85	45	3	4.0
100	45	2	4.4
115	45	1	4.8
130	45	None	5.1

NOTE. Range data for auxiliary grenade cartridge will be published when available.

**c. Range tables for impact fragmentation grenade M17 (formerly the T2).** (1) WITH M1 RIFLE (M7 LAUNCHER), M1903 RIFLES (M1 LAUNCHER), AND M1917 RIFLE (M2 LAUNCHER).

*M17 IMPACT FRAGMENTATION GRENADE*

Range	Angles of elevation (degrees)	Launcher position (rings exposed)	
		M1 rifle (M7 launcher)	M1903 rifles (M1 launcher) or M1917 rifle (M2 launcher)
55	45	6	5
80	45	5	4
105	45	4	3
130	45	3	2
155	45	2	1
180	30	None	None
200	45	None	None
260	30	None	None
		plus auxiliary cartridge M7	plus auxiliary cartridge M7
290	45	None	None
		plus auxiliary cartridge M7	plus auxiliary cartridge M7

(2) WITH M1 CARBINES (M8 LAUNCHER).

M17 IMPACT FRAGMENTATION GRENADE  
M1 CARBINES

Range	Angles of elevation (degrees)	Launcher position (rings exposed)
40	45	6
55	45	5
75	45	4
90	45	3
110	45	2
125	45	1
135	45	None

Note: Range data for auxiliary grenade cartridge will be published when available.

**d. Range tables for smoke grenade, T5. (1) WITH M<sub>1</sub> RIFLE (M<sub>7</sub> LAUNCHER), M<sub>1903</sub> RIFLES (M<sub>1</sub> LAUNCHER), AND M<sub>1917</sub> RIFLE (M<sub>2</sub> LAUNCHER).**

*T<sub>5</sub> SMOKE GRENADE*

Range (yards)	Angles of elevation (degrees)	Launcher position (rings exposed)	
		M <sub>1</sub> rifle (M <sub>7</sub> launcher)	M <sub>1903</sub> rifles (M <sub>1</sub> launcher) or M <sub>1917</sub> rifle (M <sub>2</sub> launcher)
55	30	6	5
60	45	6	5
85	45	5	4
110	45	4	3
135	45	3	2
165	45	2	1
195	45	1	-----
215	45	None	None
310	45	None plus auxiliary cartridge M7	None None plus auxiliary cartridge M7

(2) M1 CARBINES (M8 LAUNCHER).

T3 SMOKE GRENADE  
M1 CARBINES

Range (yards)	Angles of elevation (degrees)	Launcher position (rings exposed)
40	45	6
65	45	5
85	45	4
100	45	3
120	45	2
135	45	1
150	45	None
215	45	None plus auxiliary cartridge M7

**51. RANGE TABLES, FLAT-TRAJECTORY FIRE.** Grenades will be fully seated on the launcher in all flat-trajectory firing.

**a. M9A1, M11A1, and M11A2 grenades.** Sighting and aiming will be done as prescribed in paragraphs 37 and 38.

**b. Range tables for fragmentation hand grenade Mk. II, with projection adapter M1.** The following range tables will be used with this grenade. Data for auxiliary grenade cartridge will be published when available.

(1) WITH M<sub>1</sub> RIFLE (M<sub>7</sub> LAUNCHER), M<sub>1903</sub> RIFLES (M<sub>1</sub> LAUNCHER), AND M<sub>1917</sub> RIFLE (M<sub>2</sub> LAUNCHER).

*FRAGMENTATION HAND GRENADE MK. II, WITH PROJECTION ADAPTER M<sub>1</sub> M<sub>1</sub>, M<sub>1903</sub>, AND M<sub>1917</sub> RIFLES*

Range (yards)	Angles of elevation (degrees)	Time of flight (seconds)
9	1	0.2
17	2	0.3
26	3	0.5
34	4	0.7
42	5	0.8
50	6	1.0
58	7	1.2
65	8	1.3
73	9	1.5
80	10	1.7

(2) WITH M<sub>1</sub> CARBINES (M8 LAUNCHER).

FRAGMENTATION HAND GRENADE MK. II,  
WITH PROJECTION ADAPTER M<sub>1</sub>  
M<sub>1</sub> CARBINES

Range (yards)	Angles of elevation (degrees)	Time of flight (seconds)
5	1	0.1
10	2	0.3
15	3	0.4
20	4	0.5
25	5	0.6
30	6	0.8
34	7	0.9
39	8	1.0
43	9	1.1
48	10	1.3

c. **Range tables for impact fragmentation grenade M17 (formerly the T2).** The following range tables will be used with this grenade. Data for auxiliary grenade cartridge will be published when available.

(1) WITH M<sub>1</sub> RIFLE (M7 LAUNCHER), M1903 RIFLES (M<sub>1</sub> LAUNCHER), AND M1917 RIFLE (M<sub>2</sub> LAUNCHER).

*M17 IMPACT FRAGMENTATION GRENADE  
M1, M1903, AND 1917 RIFLES*

Range (yards)	Angles of elevation (degrees)
8	1
15	2
23	3
31	4
38	5
45	6
53	7
60	8
67	9
74	10

(2) WITH M1 CARBINES (M8 LAUNCHER).

*M17 IMPACT FRAGMENTATION GRENADE  
M1 CARBINES*

Range (yards)	Angles of elevation (degrees)
5	1
11	2
16	3
21	4
26	5
31	6
36	7
41	8
46	9
51	10

**52. EXERCISES IN SIGHTING AND AIMING, AND RANGE ESTIMATION. a. Exercise No. 1. (1) PURPOSE.** To familiarize students with various angles of elevation for the rifle.



(2) **METHOD.** The instructor calls off angles of elevation of  $60^\circ$ ,  $45^\circ$ , and  $30^\circ$ . The student, with rifle on ground, as shown in figure 39①, raises the muzzle until the angle of elevation corresponds to the number of degrees called by the instructor, fig. 39②). A clinometer may be used to check the accuracy of the student's estimate.

**b. Exercise No. 2.** (1) **PURPOSE.** To familiarize the student with units of measure, 50, 100, 150, 200, and 250 yards.

(2) **METHOD.** Ranges of 50, 100, 150, 200, and 250 yards are staked out on the ground. All students are required to become familiar with the appearance of these units of measure from the kneeling, modified sitting, and standing positions. Practice in range estimation should proceed in the manner outlined in paragraph 124, FM 23-5 except that units of 50 yards, instead of 100 yards, are used.

**c. Exercise No. 3.** (1) **PURPOSE.** To teach the student to find the correct angle of elevation at night.

(2) **METHOD.** With the sling marked, as described in paragraph 49b, the student is blindfolded. The instructor calls out various angles and the student from the kneeling and modified sitting positions places the rifles at the angle called.

**d. Exercise No. 4.** (1) **PURPOSE.** To enable the student to determine rapidly how far a grenade should be placed on a launcher for various ranges.

(2) **METHOD.** The instructor announces ranges to imaginary targets and requires the student to place the grenade on the launcher at the proper position.

**53. POSITIONS. a. Flat trajectory.** Positions described in paragraph 40 are suitable for antipersonnel, flat trajectory fire.

**b. High angle.** The following positions are suitable for high-angle fire:



*Figure 40. Kneeling.*

(1) **KNEELING** (fig. 40). The firer faces half right, kneels on his right knee, and places the butt of the rifle on the ground ahead of the right kneecap. The left forearm rests on the left knee, and the left hand grasps the rifle above the upper sling swivel. The left foot is placed on the sling at the marked point determining the desired angle of elevation. The body rests on the right heel. The head is aligned vertically over the rifle.

(2) **MODIFIED SITTING** (fig. 41). The firer reclines, supported by his right elbow, feet toward the target. The butt of the rifle is in a slight depression to insure stability. The right hand grasps the stock and is in a position to squeeze the trigger. The right leg is stretched straight



*Figure 41. Modified sitting.*

out, and the left leg is placed over the right with the left foot on the sling at the mark determining the desired angle of elevation. The head is aligned vertically over the rifle.

(3) **STANDING** (fig. 42). The standing position is for emergencies and is used only when tall grass, brush, or other obstacle obscures the view of the target. The position taken is similar to the one described in paragraph

40b, except for the angle at which the rifle is elevated. The rifle will not be fired from the standing position at an angle of elevation greater than  $45^{\circ}$  because of the danger that the downward pressure from the recoil will break the firer's collarbone.

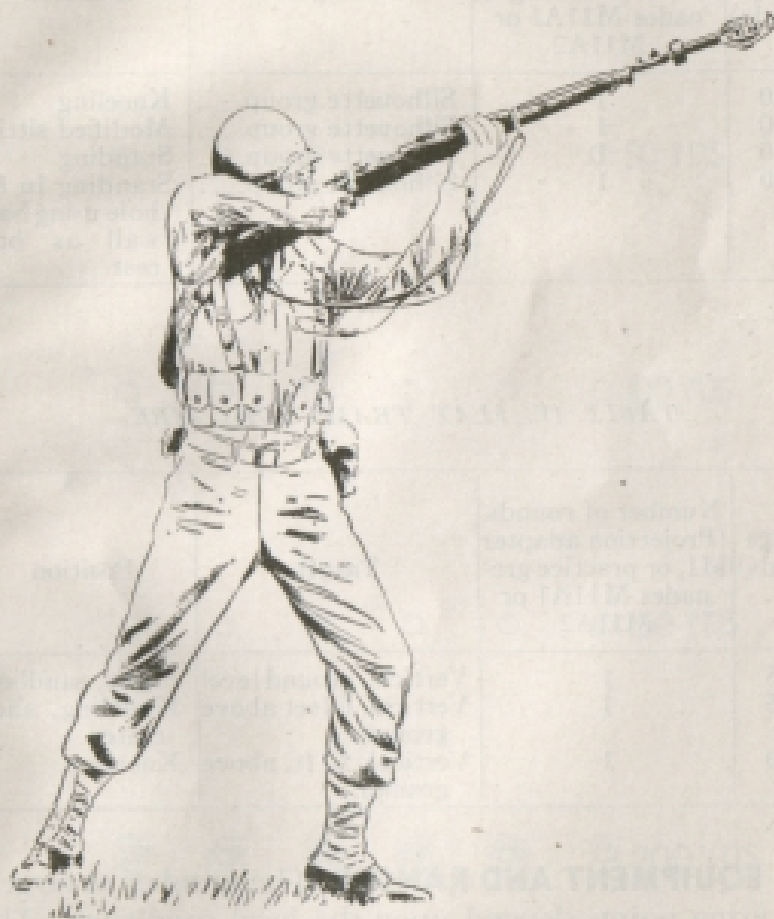


Figure 42. Standing.

**54. ANTIPERSONNEL TARGET COURSES.** When the student is proficient in the sighting and aiming exercises (par 52) and in the use of the various positions (par. 53), he should fire the target courses outlined in the following tables.

*TABLE III. HIGH ANGLE FIRE*

Range (yards)	Number of rounds (Projection adapter M1, or practice grenades M11A1 or M11A2)	Target	Position
50	1	Silhouette group....	Kneeling
100	1	Silhouette group....	Modified sitting
150	1	Silhouette group....	Standing
200	1	Silhouette group....	Standing in fox hole using back wall as butt rest

*TABLE IV. FLAT TRAJECTORY FIRE*

Range (yards)	Number of rounds (Projection adapter M1, or practice grenades M11A1 or M11A2)	Target	Position
25	1	Vertical, ground level	Prone, sandbag
45	1	Vertical, 6 feet above ground.	Kneeling, shell crater
70	1	Vertical, 12 ft. above ground.	Kneeling

**55. EQUIPMENT AND RANGES.** The number of targets and firing points depend upon the local conditions. The following lay-outs are suggested:

**a. High-angle** (fig. 43). The range is 200 yards long with the targets located at the far end. Firing points are established at ranges of 50, 100, 150, and 200 yards from the targets. The fox holes are dug only at the 200-yard firing points.

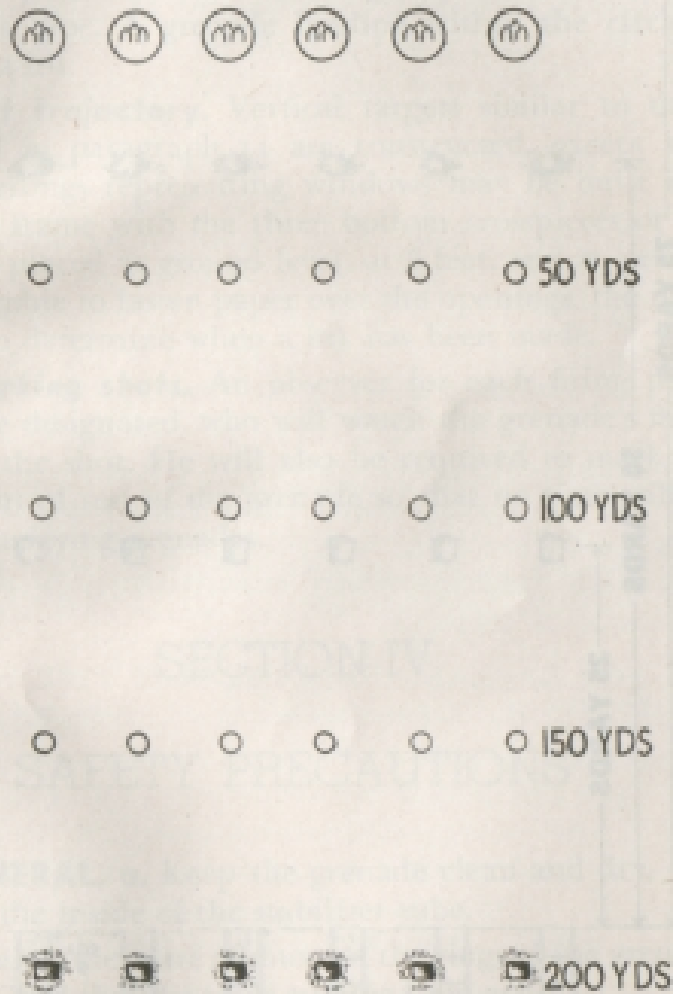


Figure 43. Silhouette court for high angle antipersonnel marksmanship.

**b. Flat trajectory** (fig. 44). The range is 75 yards long with six targets at the far end. Sandbags are placed

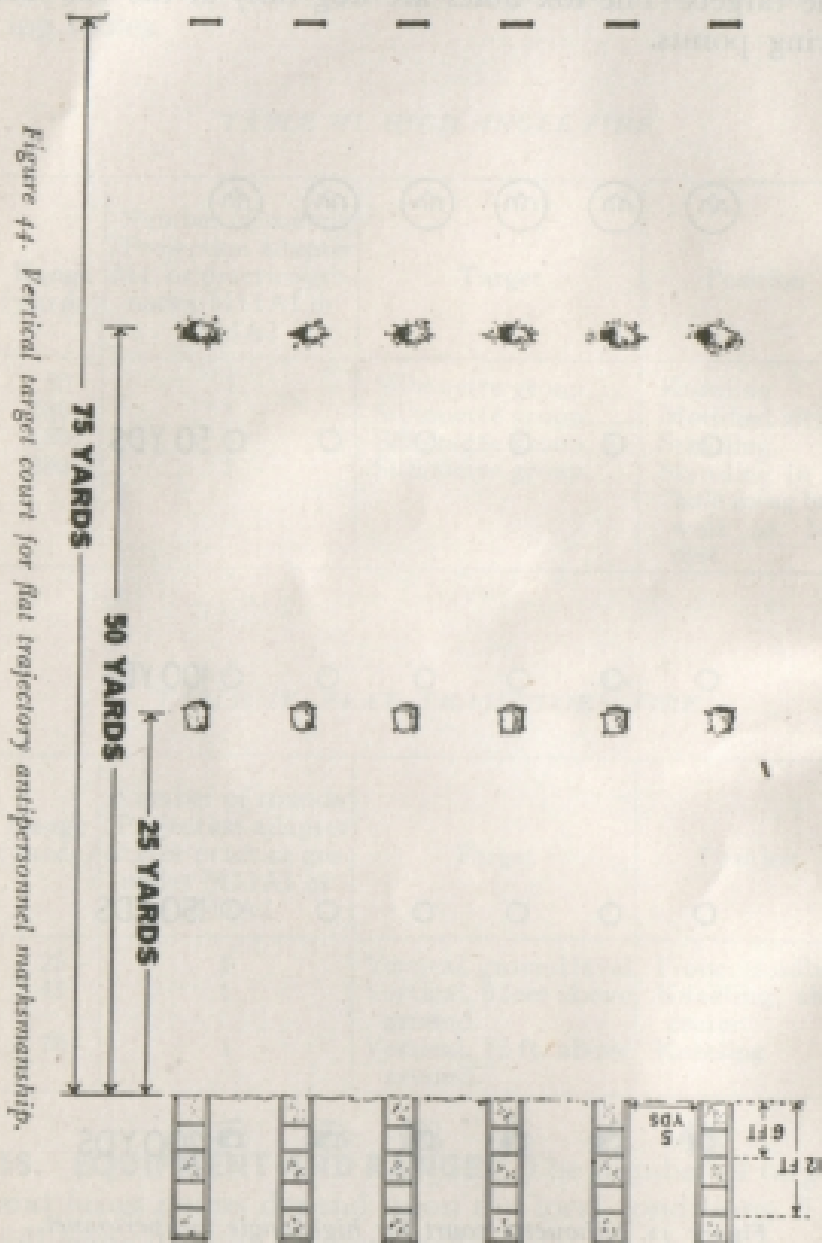


Figure 44. Vertical target court for flat trajectory antipersonnel marksmanship.

at the 25-yard mark, shell craters are dug at the 50-yard mark, and other firing points are indicated by stakes at the 75-yard mark.

**56. TARGETS. a. High-angle.** The target for each firing point is a group of three silhouette targets representing a weapon crew. Around each group a circle with the radius of 5 yards from the center of the group is described with engineer's tape. A grenade landing within the circle is counted a hit.

**b. Flat trajectory.** Vertical targets similar to those described in paragraph 11 are constructed, except that three openings representing windows may be built into the same frame with the three bottom crosspieces of the openings placed at ground level, at 6 feet, and at 12 feet. It is desirable to fasten paper over the openings, the more readily to determine when a hit has been made.

**c. Marking shots.** An observer for each firing point should be designated, who will watch the grenade's flight and call the shot. He will also be required to mark the final point of rest of the grenade so that no time will be lost in retrieving grenades.

## SECTION IV

### SAFETY PRECAUTIONS

**57. GENERAL. a.** Keep the grenade clean and dry, particularly the inside of the stabilizer tube.

**b.** See that there are no burs on the rings of the grenade launcher, and that the rings are free from grit.

**c.** Inspect frequently the wing nut on the clamp of the launchers M1, M2, and M8 to insure that it is tight.



**d.** Never place a grenade on the launcher unless it is intended to fire it immediately. *Never fire service ammunition or standard blank ammunition when grenade is on the launcher.*

**e.** Test each grenade to insure that it moves freely on launchers M<sub>1</sub> and M<sub>2</sub>.

**f.** In the event a fragmentation hand grenade with adapter fails to explode (dud) it will be disposed of in the manner prescribed in paragraph 24.

**g.** After placing the grenade on either the M<sub>1</sub> or M<sub>2</sub> launcher, keep the rifle elevated above the horizontal, except when it is necessary to fire at a minus angle of elevation. When firing at a minus elevation, lower the rifle gently as the aim is taken or lead is applied in order to prevent the grenade from sliding from the launcher. When firing the grenade with either the M<sub>1</sub> or M<sub>2</sub> launcher at a considerable minus angle of elevation, such as from the top of a cliff to beaches below, some means must be employed to keep the grenade from falling entirely off the rifle. One method is to loop a single strand of ordinary thread over the fin of the grenade and then tie the loop tightly behind the bayonet lug. When the grenade is fired, the fin's edge will cut the thread. A number of grenades can be so prepared ahead of time if the occasion demands.

**58. FOR GRENADES WITH IMPACT TYPE FUZES.** In addition to the safety precautions listed above and in paragraph 32c, observe the following:

**a.** All rules pertaining to firearms in general.

**b.** In the event the rifle grenade cartridge M<sub>3</sub> or carbine grenade cartridge M<sub>6</sub> does not fire and there are no additional M<sub>3</sub> or M<sub>6</sub> cartridges available, lock the weapon, replace the grenade safety pin, and remove the grenade.

**c.** Personnel engaged in firing must wear the helmet and assume the prone position face down during the time the grenade is in flight, or use cover, such as a fox hole.

**d.** Personnel not firing should not approach within 125 yards of the target, nor within an angle of  $30^\circ$  on either side of the line of flight of the M9A1 antitank grenade or the impact fragmentation rifle grenade M17.

**e.** The use of helmets by personnel not firing and by spectators is optional.

**f.** When firing service antitank grenades for practice, the following precautions will be observed to insure detonation, thus reducing the number of duds.

(1) Targets of suitable hardness, rigidity, and reasonably flat surface will be used.

(2) The ideal angle of impact is a head-on hit. Variations from this should not be greater than  $20^\circ$ .

**g.** In the event that a grenade with an impact type fuze (M9A1, M17, or T5) fails to detonate upon impact (dud), it will be destroyed in place by competent personnel. (See par. 24a (1)).

## SECTION V

### ADVICE TO INSTRUCTORS

**59. GENERAL.** Training in use of rifle grenades must not be restricted to hard and fast rules. Nothing in this chapter is to be construed as limiting in any way the initiative and originality of the instructors, providing necessary safety precautions are observed.

**60. METHOD OF INSTRUCTION. a. Applicatory system.** Instruction should be imparted by means of explanation, demonstration, and imitation. The coach-and-pupil method should be used throughout.

**b. Assistant instructors.** A number of noncommissioned officers or specially selected privates should be trained in advance as assistant instructors. There should be at least one assistant instructor for every six-man group.

**61. SCOPE OF TRAINING. a. General.** (1) The schedule of instruction and scope of training are dependent upon the length of time available, the combat duties of the personnel to be trained, and ammunition allowances. A minimum of three men should receive antitank marksmanship training for each rifle designated for antitank defense in Infantry Tables of Organization.

(2) All riflemen should receive sufficient training in the antipersonnel use of the rifle grenade to familiarize them with its capabilities and limitations.

(3) When the rifle grenade is fired at high angles it becomes, in effect, a squad mortar. In order to place surprise fire or fire for effect on a target under combat conditions, a maximum rate of fire is the principal consideration. It will, therefore, be necessary to pull the safety pins of several grenades before commencing to fire. Instructors will, whenever possible, demonstrate the use of the rifle grenade, firing live grenades.

**b. Allotment of time.** (1) The following apportionment of the time allotted for rifle grenade training is suggested:

Period	Hours (percent of total)	Instruction	Equipment
1	10%	Conference, demonstration, and practical work in use of accessories and in sighting and aiming. (Secs. II and III.)	Rifles with launchers; practice rifle grenades; rifle rest; target frame; 20-inch aiming disk.
2	10%	Conference, demonstration, and practical work in positions and sequence of operations in loading and firing. (Secs. II and III.)	Rifles with launchers; target frame; practice rifle grenades; sandbags; shell craters, standing type one- or two-man fox holes.
3	40%	Firing stationary target course, antitank and antipersonnel.	Same equipment as above; stationary targets; rifle grenade, cartridges.
4	40%	Conference on range estimation and leads. Demonstration of method of firing at moving targets. Firing moving target course.	Same equipment as above. Trucks and sleds for moving targets.

(2) At the beginning of each period of instruction, the entire class should be assembled and the officer in charge should cover the work of the period with a brief conference and demonstration. Practical work should be conducted by assistant instructors in charge of each group.

**c. Additional training.** After the moving target course has been fired, all individuals undergoing instruction should receive further training in firing at field targets.

## CHAPTER 3

### ROCKET, AT, 2.36-INCH AND LAUNCHER

---

#### SECTION I

#### GENERAL

#### **62. BASIC DOCTRINE GOVERNING EMPLOYMENT.**

a. The antitank rocket launcher, 2.36-inch, is both an offensive and defensive weapon. In both types of action it is used primarily against hostile armored vehicles which come within effective range. It is also employed against emplaced automatic weapons, buildings, and embrasures. The weapon is essentially one of opportunity. In the hands of trained personnel, it is a powerful supporting weapon at short ranges.

b. No additional personnel are allotted for the operation of the launchers and rockets. They will be operated and properly cared for by designated personnel in addition to their regularly assigned duties. They will not ordinarily be used while men are engaged in their primary duties except when necessary to repel a mechanized attack. Rockets are supplemented by the antitank grenade in the hands of rifle grenadiers.

c. To provide necessary assistance in loading and reloading, the launcher is normally operated by a team

of two men. (See fig. 45.) In emergencies it may be operated by one man. For mutual support, it is highly desirable that teams of rocketeers work in pairs (or threes) and be so located that they may obtain flanking fire against the lighter armor on the sides or rear of hostile mechanized vehicles. Employment of launchers in pairs (or threes) will facilitate the action of combating



*Figure 45. Rocket team.*

two or more hostile armored vehicles which attack simultaneously from different directions.

**d.** As many individuals should be trained in the use of the launcher and rockets as training time and ammunition will permit.

**63. BASIS OF ISSUE.** The basis of issue of launchers is prescribed in the Tables of Organization and Equipment of the particular arm or service.

## SECTION II

### CHARACTERISTICS AND DESCRIPTION OF ANTITANK ROCKET LAUNCHERS M1A1 AND M9

**64. CHARACTERISTICS.** **a. General.** The antitank rocket launcher M1A1 or M9 is a smooth-bore, breech-loading, electrically-operated, shoulder weapon of the open-tube type. It is used to launch high-explosive rockets and is fired from the standing, kneeling, sitting, or prone positions.

**b. Purpose.** The primary function of the launcher is to give direction to the rocket. There is no recoil since the propulsion of the rocket is accomplished by the jet action of the propellant powder in the stabilizer tube of the rocket and does not depend upon gas pressure built up inside the launcher tube. The launcher tube, therefore, need only be heavy enough to prevent denting or bending during handling and to prevent excessive heating at normal rates of fire.

**65. GENERAL DATA.** General data of the antitank rocket launchers M1A1 and M9 are as follows:

Length:

M1A1 ..... 54.5 inches  
M9 ..... 61 inches

Weight:

M1A1 ..... 13.26 pounds  
M9 ..... 15 pounds

Diameter, internal ..... 2.36 inches

Range:

Point targets ..... 50 to 300 yards  
Area targets ..... 300 to 650 yards

Elevation for maximum range.....40°

**66. DESCRIPTION OF LAUNCHER M1A1. a. Nomenclature.** The launcher M1A1 is equipped with sights, hand grip, stock, sling, firing mechanism, face guard, breech guard tail latch, and flash deflector. (See figs. 46, 47, and 48.)

**b. Component parts.** (1) SIGHTS (fig. 47). The front and rear sights are mounted on the left side and are 20<sup>7</sup>/<sub>8</sub> inches apart. The front sight consists of three studs representing ranges of 100, 200, and 300 yards. The rear sight is a peep sight. The sights being fixed, the gunner must estimate intermediate ranges, ranges in excess of 300 yards, and the windage and lead.

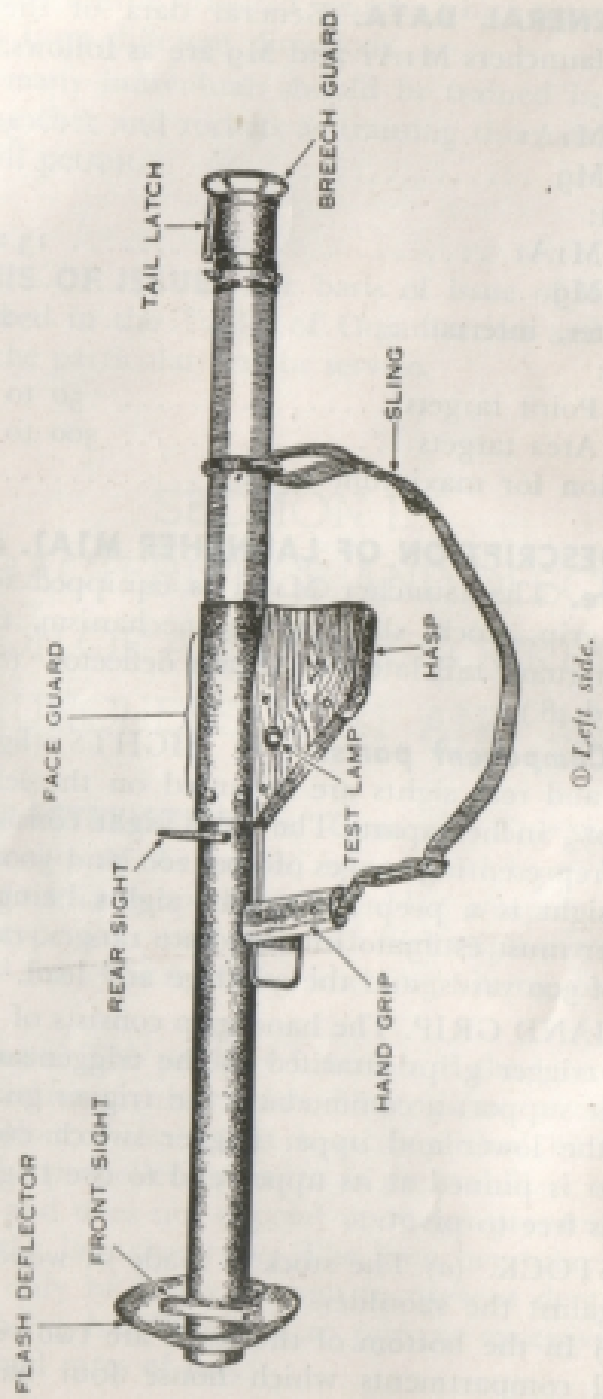
(2) HAND GRIP. The hand grip consists of the left and right trigger grips attached to the trigger support. The trigger support accommodates the trigger guard, trigger, and the lower and upper trigger switch contacts. The trigger is pinned at its upper end to the trigger support and is free to pivot.

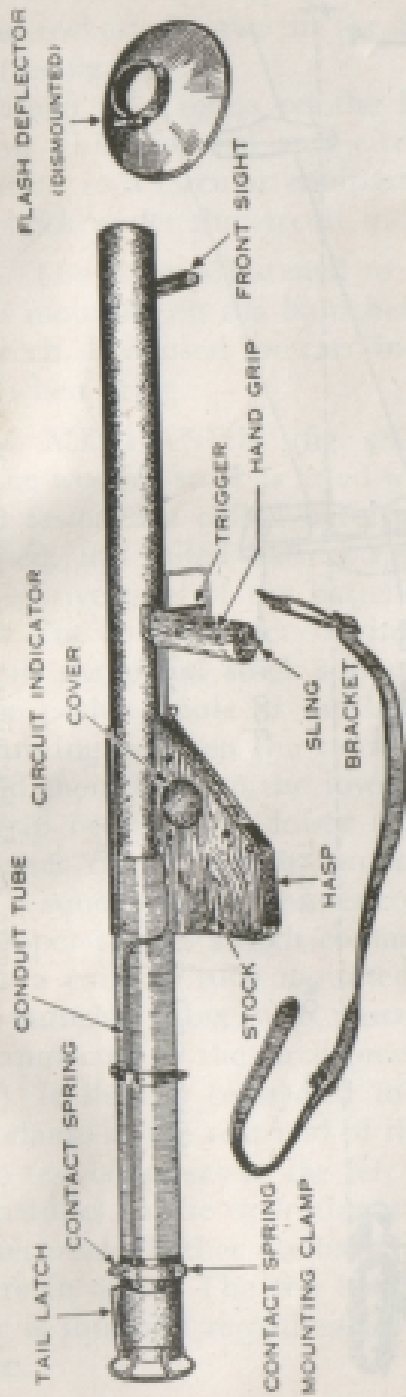
(3) STOCK. (a) The stock is made of wood, shaped to fit against the shoulder.

(b) In the bottom of the stock are two vertical cylindrical compartments which house four batteries. The

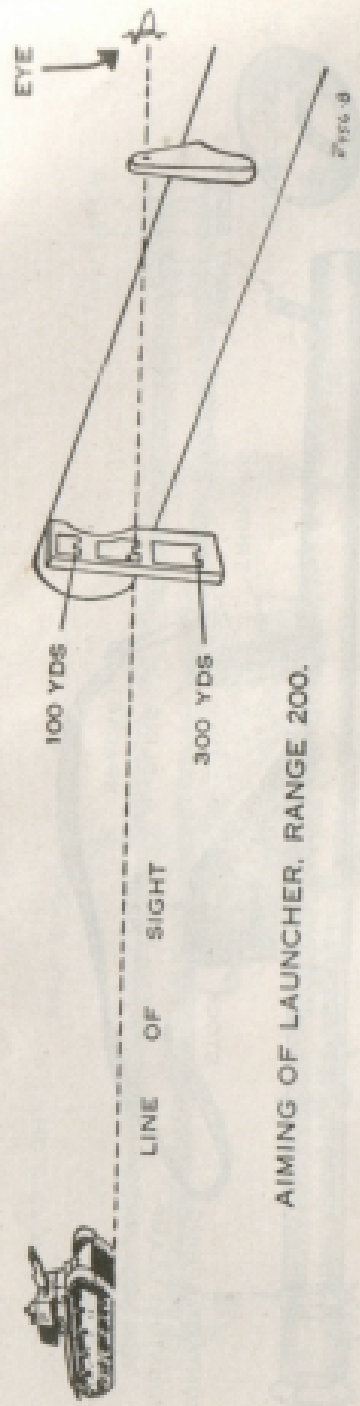


Figure 46. Launcher M. A. I.





© Right side.



AIMING OF LAUNCHER. RANGE 200.

Figure 47. Sights; aiming the launcher M.I.A.

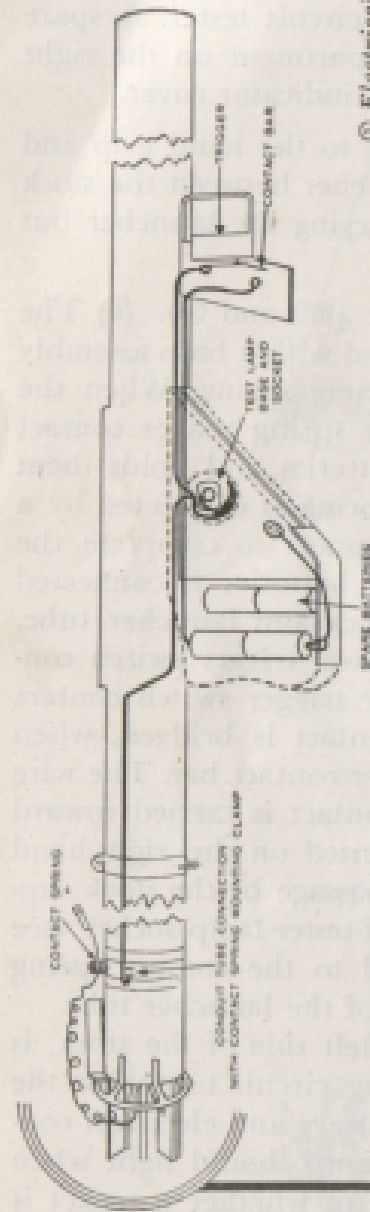
two batteries in the rear compartment supply the current to ignite the rocket; the two in the front compartment are spares. (See fig. 48①.)

(c) Contained in a recess on the left side is a small electric lamp which is used as a circuit tester. A spare lamp is carried in a circular compartment on the right side of the stock under the circuit indicator cover.

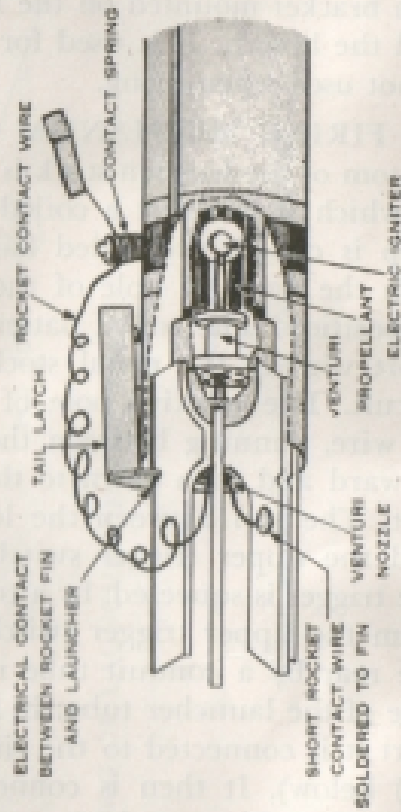
(4) SLING. The sling is fastened to the hand grip and to a bracket mounted on the launcher between the stock and the breech. It is used for carrying the launcher but is not used when firing.

(5) FIRING MECHANISM (fig. 48① and ②). (a) The bottom of the wooden stock is fitted with a hasp assembly to which is fastened a coiled battery spring. When the hasp is closed, the coiled battery spring makes contact with the negative pole of the batteries and holds them in position. The coiled battery spring is connected by a short wire to the metal stock support to complete the circuit. The positive pole of the batteries is connected by wire, running between the stock and launcher tube, forward and then down to the lower trigger switch contact. The gap between the lower trigger switch contact and the upper trigger switch contact is bridged, when the trigger is squeezed, by a copper contact bar. The wire from the upper trigger switch contact is carried toward the rear by a conduit tube mounted on the right-hand side of the launcher tube; in its passage by the stock support it is connected to the circuit-tester-lamp socket (see (b) below). It then is connected to the contact spring mounting clamp at the rear end of the launcher tube.

(b) The test lamp, set in the left side of the stock, is wired in parallel to the operating circuit to enable the firer to determine whether the battery and electrical connections are in order. The test lamp should light when the trigger is squeezed regardless of whether a rocket is in the tube.



① Electrical circuit on launcher.



② Method of completing circuit between rocket and launcher.

Figure 48. Firing mechanism wiring diagram, launcher M1A1.

(6) **FACE GUARD.** The face guard is a curved metal plate 10 inches long which fits closely around the launcher tube, projecting about 2 inches forward of the stock. It protects the face of the gunner when the tube becomes heated through firing. (See fig. 46①.)

(7) **BREECH GUARD.** The breech guard is a flaring metal ring mounted on the rear of the tube. It facilitates loading the rocket, prevents denting of the tube during handling, and prevents dirt and mud from entering the tube when its rear end is resting on the ground. (See fig. 46①.)

(8) **TAIL LATCH.** The tail latch is a spring-actuated latch situated on the top of the launcher tube and projecting over the breech. When a rocket is inserted in the tube, the latch engages in one or two of the notches on the tail fins of the rocket and keeps the rocket from sliding either farther into or out of the tube while the weapon is being aimed. That part of the latch which engages the notches, and the notches themselves, are unpainted in order that the electric circuit to the igniter in the stabilizer tube of the rocket will be grounded through the launcher tube. The contact edge of the tail latch and the notches are cammed to permit the automatic release of the rocket when it is fired. (See figs. 46① and 48.)

(9) **FLASH DEFLECTOR.** Normally the propellant charge contained in the stabilizer tube has completely burned before the rocket leaves the launcher. Occasionally, however, especially in cold climates, the burning is somewhat retarded, creating a backflash as the rocket leaves the muzzle. The deflector prevents particles of unburned powder from blowing back onto the gunner's face and hands. The deflector is made of fine wire mesh with a rigid wire frame of a conical shape. It is fastened

to the tube by a mounting clamp with screw and nut, and is mounted flush with the muzzle end of the launcher. (See fig. 46①.)

**67. DESCRIPTION OF LAUNCHER M9. a. General.**

The launcher M9 is a later model than the launcher M1A1 and is standard. It has a two-piece barrel; for carrying, the two pieces can be secured sideways to one another. The other chief differences between the two models are in the sight, hand grip, stock, firing mechanism, and flash deflector. The launcher M9 has no face guard. (See fig. 49① and ②.)

**b. Component parts. (1) SIGHTS.** The launcher M9 has no front sight. The optical ring sight provides a simple means for determining elevation settings and for estimating leads in tracking moving targets. The sight, which is screwed into the sight mounting bracket, consists of a lens frame with a lens and lens cover, range indicator, and range scale. The hinge stud permits the sight to be folded against the sight bracket when not in use or to be snapped into extended position for use in firing. The lens cover can be snapped over the front of the lens to protect it. The sight rotates on its indicator arm stud to provide for elevation. The indicator arm, which clicks into detent on the range scale, holds the sight in position. The lens of the sight gives the impression of having concentric rings with dark transparent lines crossing at right angles in the center of the field. The horizontal line is used to maintain elevation when aiming at a moving target and the concentric rings are used in estimating the lead. The range scale is secured to the sight mounting bracket by two screws. The sight can be zeroed by loosening the screws and moving the range scale up or down as desired. By loosening the nut on the bottom of the sight it is possible to set the sight for deflection. The range scale is graduated in 50-yard inter-

vals with each 100 yards numbered. The numbers run from 0 to 7, corresponding to a range from 0 to 700 yards.

**NOTE:** Some M9 launchers will be issued with a bar sight instead of the optical ring sight.

(2) **HAND GRIP.** The hand grip houses the firing mechanism which is secured to the trigger grip support on the under side of the rear barrel.

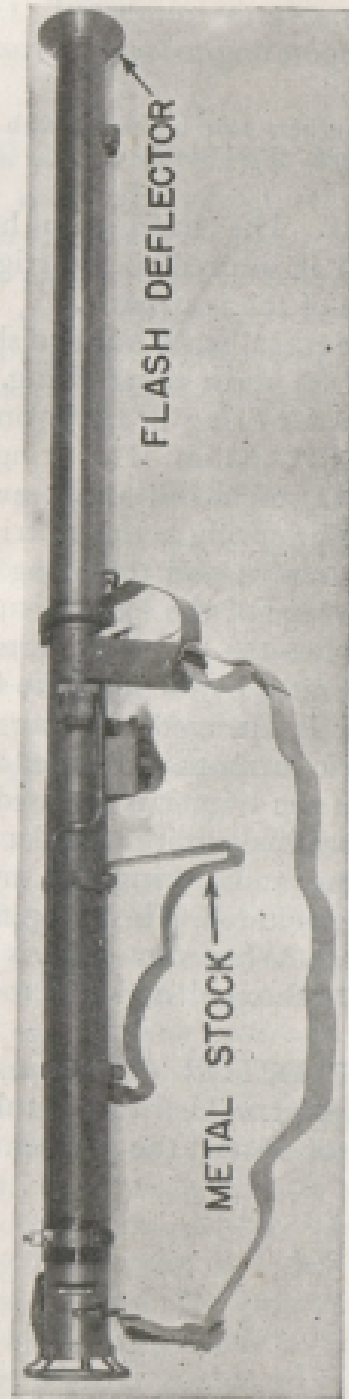
(3) **STOCK.** The metal stock has two shoulder rests; the front rest is used for short range firing, the rear rest for longer ranges and for firing in the prone position.

(4) **FIRING MECHANISM.** The firing mechanism consists of magnets housing a coil and a spring actuated bar within the coil. The spring actuated trigger is pinned to the trigger grip support and the firing mechanism. The circuit for the passage of the electric current is complete at all times, but when the trigger is in its normal position, no current is generated by the magneto firing mechanism. When the trigger is squeezed, the bar within the coil is rotated and electric current is generated and flows through the circuit. When the trigger is released, the bar magnet is rotated to its original position under the action of the bar magnet spring and during this movement electric current is again generated. The firing mechanism is provided with a safety. When the safety is put at **SAFE**, the electric current is shunted and the rocket is prevented from firing.

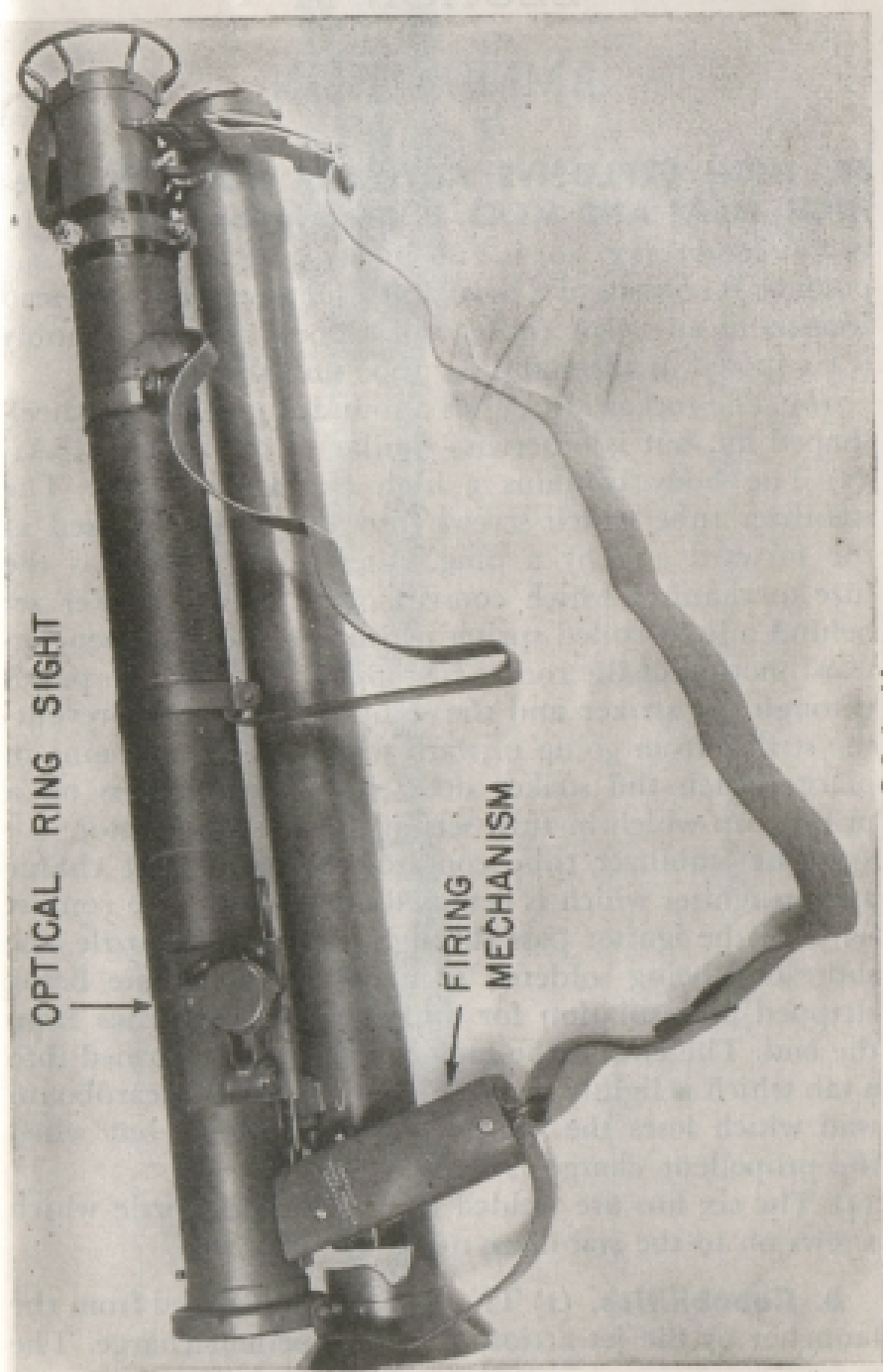
(5) **FLASH DEFLECTOR.** The muzzle flash deflector is of solid metal, spot welded to the tube, with the cone end of the deflector toward the gunner.



Figure 49. Launcher M9.



© Right side.



OPTICAL RING SIGHT

FIRING MECHANISM

© Left side.

## SECTION III

### AMMUNITION

#### **68. HIGH EXPLOSIVE ANTITANK ROCKETS, 2.36-**

**INCH, M6A1 AND M6A3. a. Description.** (1) (a) The rocket M6A1 (fig. 50) is 21.6 inches long and weighs 3.4 pounds. It consists of a head and a fin assembly. The head consists of an ogive (nose) and a body; the fin assembly is composed of the stabilizer tube and the fins.

(b) The rocket M6A3 has a rounded nose and a wheel-shaped fin, but is otherwise similar to the rocket M6A1.

(2) The body contains a high explosive charge. The stabilizer tube which screws into the body is closed at the forward end by a plug. Ahead of the plug is the fuze mechanism which consists of an inertia striker set behind a light coiled spring which is collapsed when forward motion of the rocket is stopped. A safety pin passes through the striker and the stabilizer tube and prevents the striker from going forward while the pin remains in place. When the striker does go forward it sets off a primer cap which in turn sets off the base detonator.

(3) The stabilizer tube contains the propellant charge and an igniter which is actuated electrically. The contact wires of the igniter pass through the Venturi nozzle, the short one being soldered to a fin, the long one being stripped of insulation for approximately 6 inches from the end. The end of the long contact wire is formed into a tab which is lightly taped to another fin. The cardboard wad which closes the Venturi nozzle is blown out when the propellant charge is ignited.

(4) The six fins are welded to the Venturi nozzle which screws on to the stabilizer tube.

**b. Capabilities.** (1) The rocket is discharged from the launcher by the jet action of the propellant charge. The

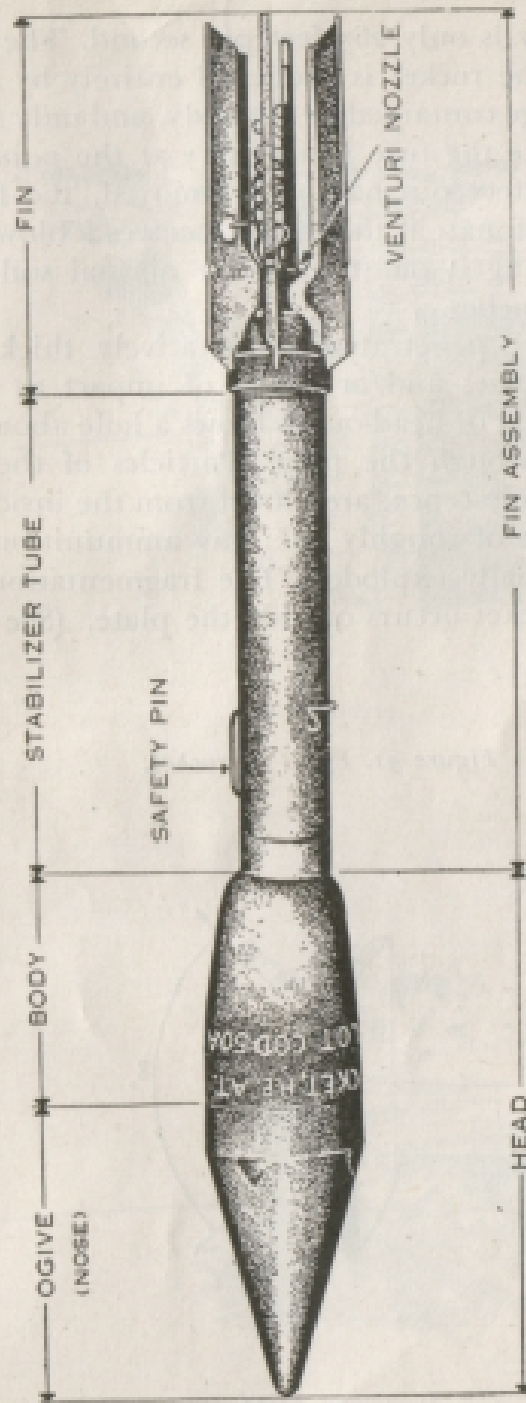
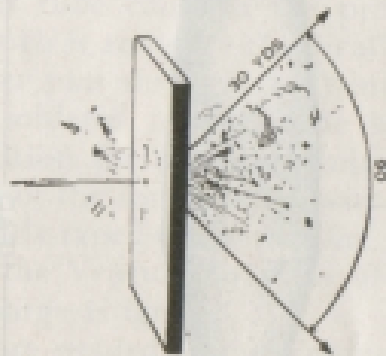


Figure 39. High explosive antitank rocket, 2.36-inch, M64r.

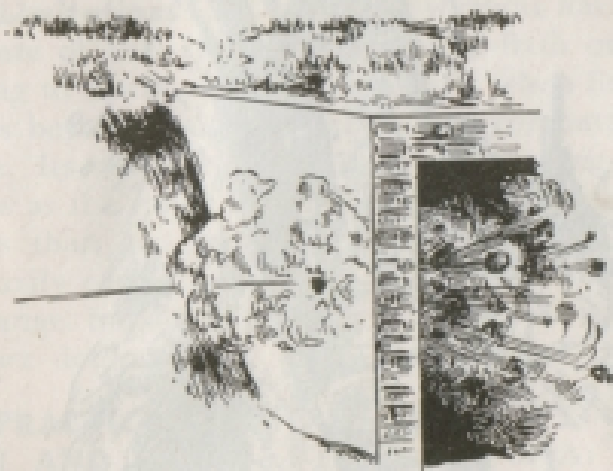
muzzle velocity is only 265 feet per second. The destructive effect of the rocket is produced entirely by the high explosive charge contained in the body, and only sufficient force to operate the fuze is necessary at the point of impact. If the safety pin has been removed, the fuze will operate and detonate if the rocket receives a blow equivalent to dropping it on its nose on normal soil from a height of 48 inches.

(2) The rocket penetrates comparatively thick armor plate at all ranges and at angles of impact as great as  $60^\circ$  from normal or head-on; it blows a hole about 1 inch in diameter through the plate. Particles of the armor, heated to incandescence, are blown from the inside of the plate in a cone of roughly  $90^\circ$ ; any ammunition within the cone is usually exploded. The fragmentation of the body of the rocket occurs outside the plate. (See fig. 51.)

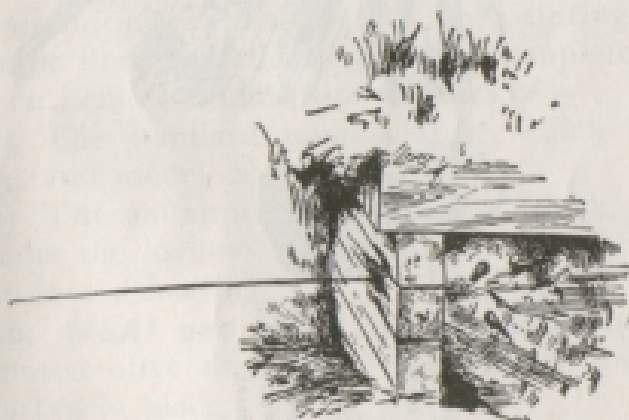
*Figure 51. Effect of rocket.*



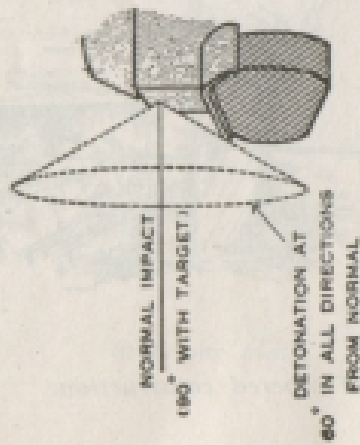
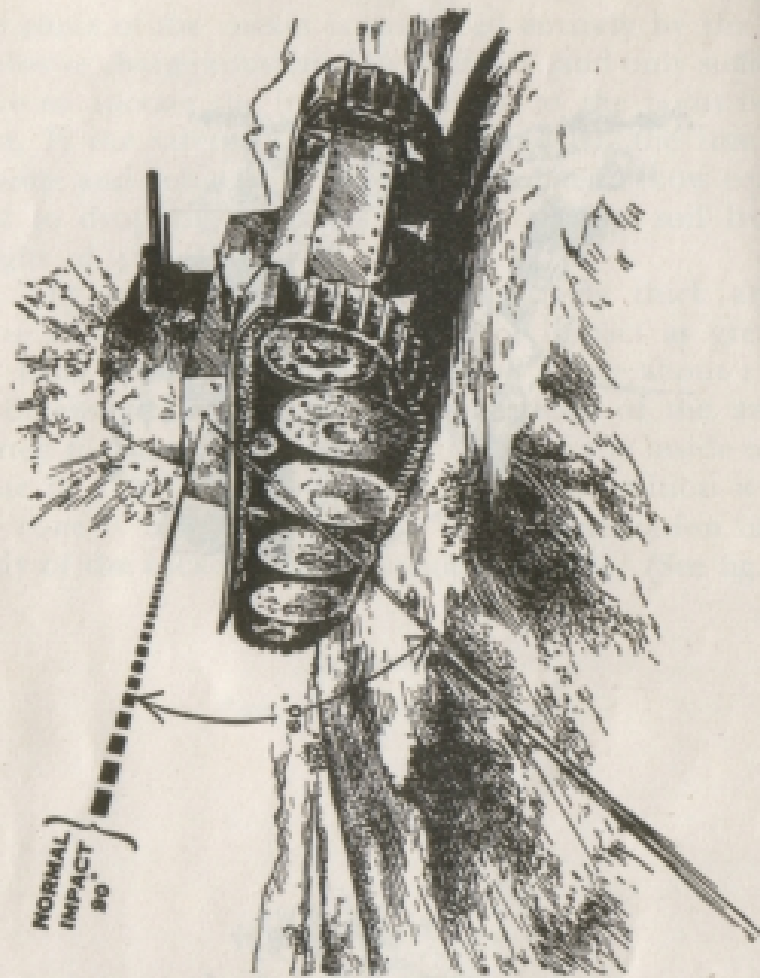
Ⓢ *Armor plate.*



① *Masonry.*



② *Timbered construction.*



© Penetration at angles at 60° from normal (top)

(3) It will penetrate brick or rock masonry, or timbered construction up to a considerable thickness.

**c. Limitations** (fig. 52). The weapon has a relatively low rate of fire; it has a distinctive flash on discharge, tending to disclose the position; and when fired at point targets beyond 300-yards range, it is comparatively inaccurate. Its accuracy when fired at moving targets decreases as the range increases. When fired on flat terrain at less than 300 yards range, impact with the ground ordinarily causes a ricochet and failure to detonate. At any range, impact with mud, soft sand, or water will not produce detonation.

**69. PRACTICE ANTITANK ROCKETS, 2.36-INCH, M7A1 AND M7A3.**

**a.** The rocket M7A1 (fig. 53) is identical in size, weight, and external appearance to the rocket M6A1 but contains no high-explosive charge in the body. It has the same propellant charge in the stabilizer tube for discharging it from the launcher.

**b.** The rocket M7A3 is similar to the rocket M7A1 but has a rounded nose and a wheel-shaped fin.

**70. IDENTIFICATION AND MARKINGS.**

**a. Method.** Ammunition is identified by the painting and marking on the item and all its packings. Complete identification of an item of ammunition consists of —

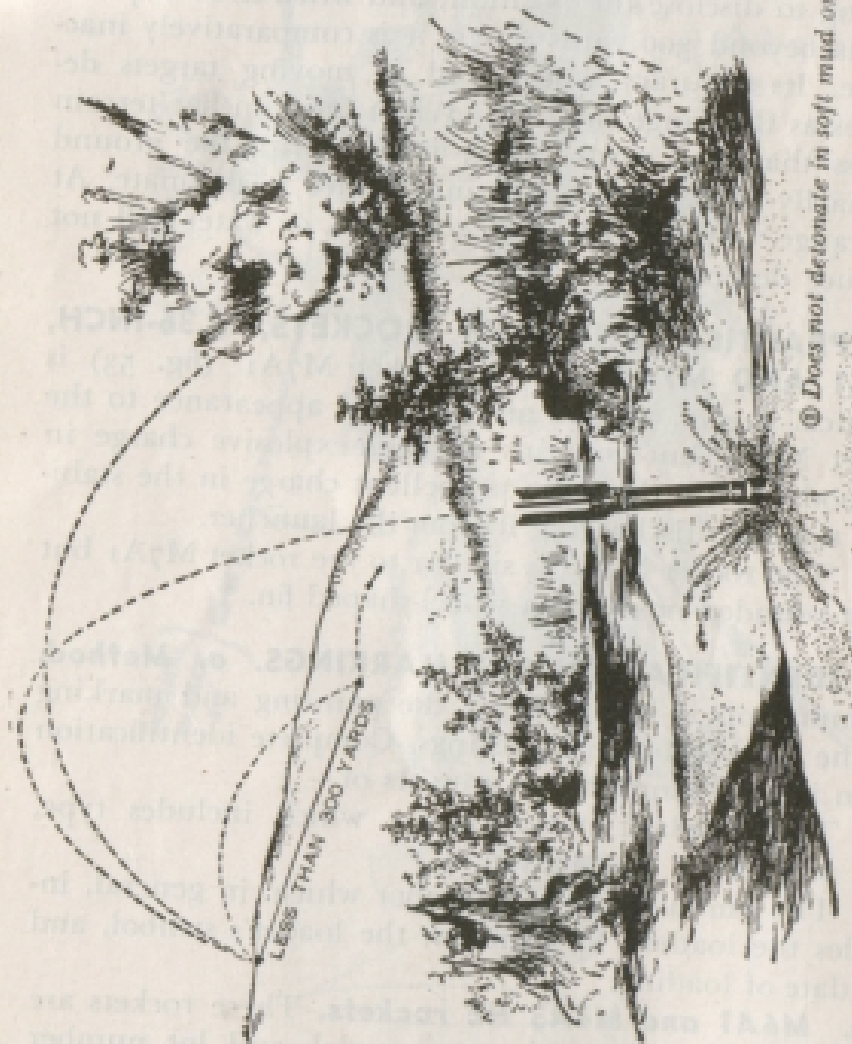
(1) The standard nomenclature which includes type, size, and model designation.

(2) The ammunition lot number which, in general, includes the loader's lot number, the loader's symbol, and the date of loading.

**b. M6A1 and M6A3 HE rockets.** These rockets are painted olive drab with type, model, and lot number marked in black.

**c. M7A1 and M7A3 practice rockets.** These rockets are painted black with type, model, and lot number marked in white.





© Does not detonate in soft mud or sand.

Figure 52. Limitations of rocket.

© Ricochets.

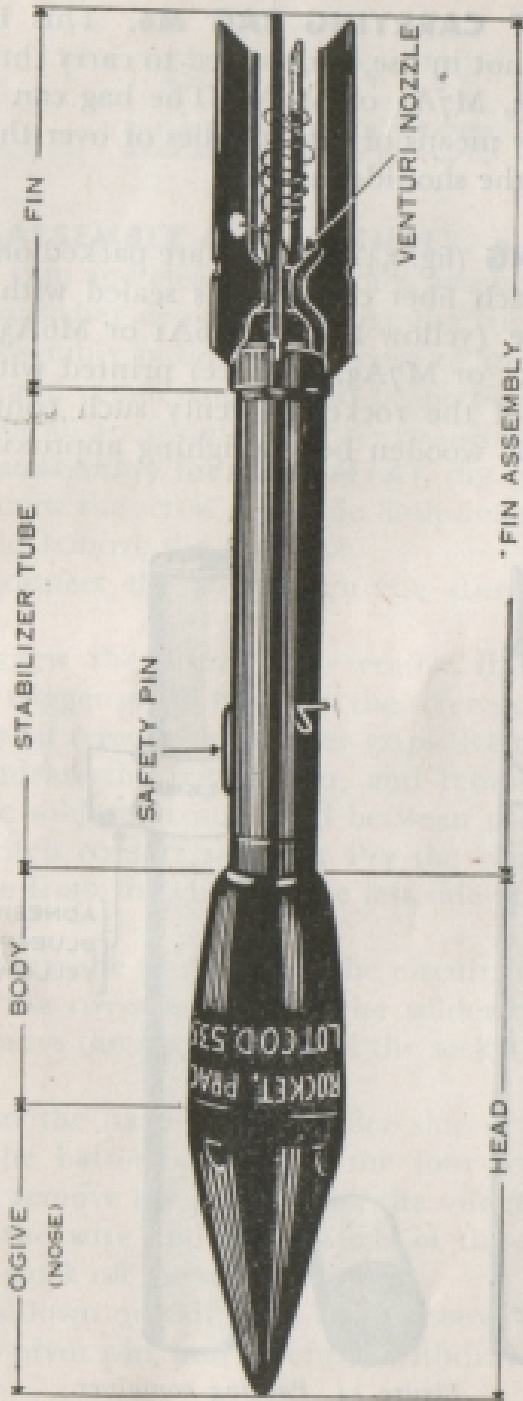


Figure 53. Practice antitank rocket, 2.36-inch, M7Ar.

**71. ROCKET CARRYING BAG M6.** This bag, easily stored when not in use, is designed to carry three rockets, M6A1, M6A3, M7A1 or M7A3. The bag can be carried at the side by means of side handles or over the shoulder by means of the shoulder strap.

**72. PACKING** (fig. 54). Rockets are packed one per fiber container. Each fiber container is sealed with a strip of adhesive tape (yellow for the M6A1 or M6A3, and blue for the M7A1 or M7A3, practice) printed with the type and model of the rocket. Twenty such containers are packed to the wooden box, weighing approximately 128 pounds.

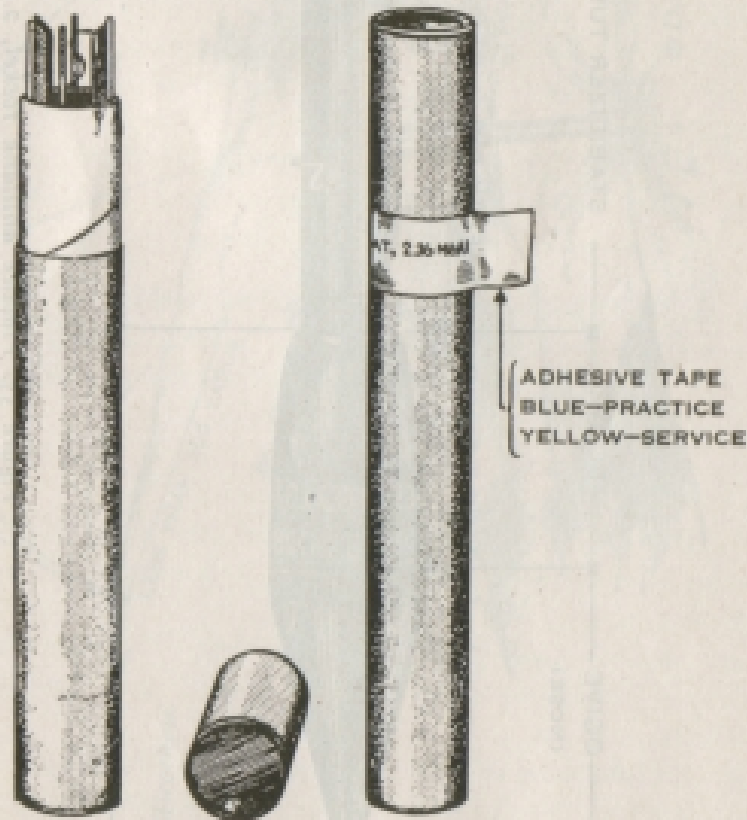


Figure 54. Packing container.

## SECTION IV

### MAINTENANCE

**73. DISASSEMBLY AND ASSEMBLY. a. General.** For ordinary care and cleaning, it is not necessary to disassemble the launcher except to remove the trigger grips. Further disassembly is for the purpose of inspection, maintenance, and repair and should be performed under the supervision of an *armorers-artificer or ordnance personnel*.

**b. Disassembly launcher M1A1** (fig. 55, 56, and 57).

(1) Unscrew the screw from the flash deflector mounting clamp and remove the deflector.

(2) Disconnect the sling from the sling loops on the launcher.

(3) Unscrew the screws and remove the sling bracket from the trigger grips. Unscrew the screws on the left trigger grip and remove the trigger grips. Remove the cotter pin, withdraw the trigger pin, and remove the trigger. Break the soldered connection between the wire and the lower switch contact support. Pry the conduit with the wire loose from the clips on the left side of the stock support.

(4) Unscrew the screws from the circuit indicator cover. Remove the cover and break the soldered wire connection. Remove the spare bulb and the socket assembly with bulb.

(5) Open the hasp on the under side of the stock and remove the batteries. Remove the four screws from the hasp and remove the hasp. Break the soldered connection between the wire and the bottom of the stock support. Slide the stock off the support.

(6) Press down on tail latch body remove cotter pin and tail latch pivot pin, and carefully withdraw the tail latch spring.

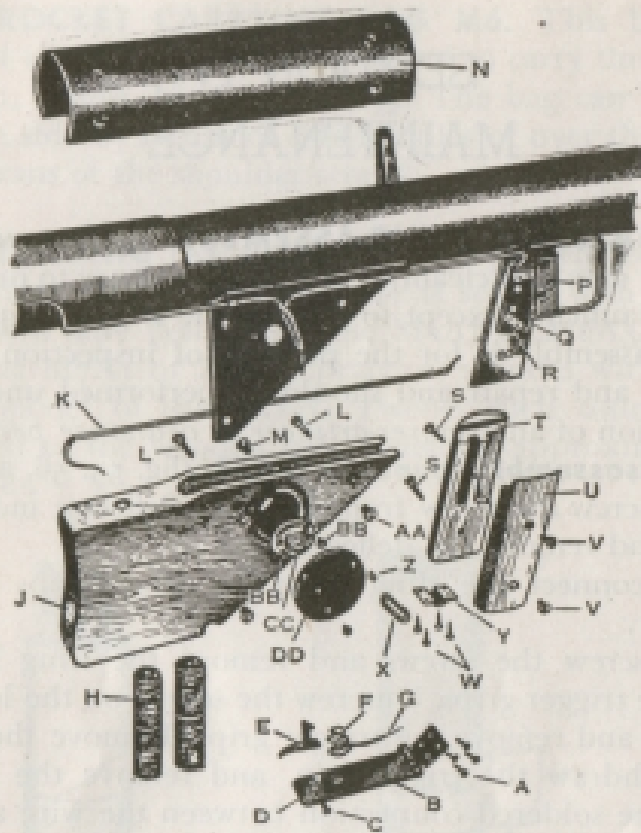


Figure 35. Stock and grip group, launcher M1A1.

**c. Assembly, launcher, M1A1.** (1) Place tail latch spring in position over the stud between tail latch shunt and tail latch body. Press down on tail latch body and insert the tail latch pivot pin and secure it with the cotter pin.

(g) Solder the broken connections between the wire and lower switch contact support, between the wire and upper stock contact, and between the wire (on the battery spring) and the bottom of the stock support.

(g) Slide the stock partly onto the stock support. Keep the wire between stock support and battery spring moving in the slot in the stock so as not to break the soldered connections. Replace the conduit with the wire in the

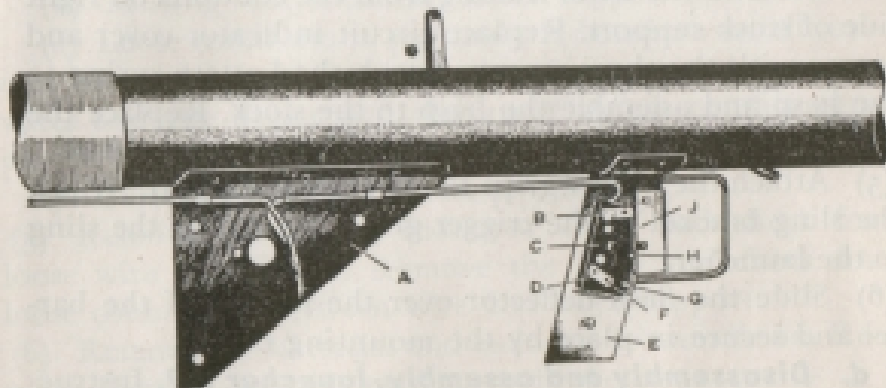


Figure 56. Trigger group, launcher M1A1.

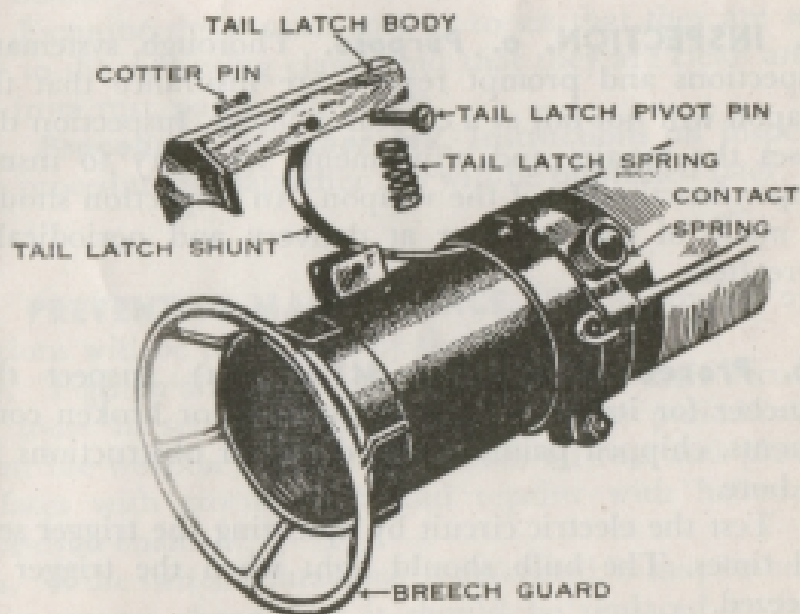


Figure 57. Rear of launcher M1A1 or M9.

clips on the left side of the stock support. Push stock into position on the stock support.

(4) Assemble light bulb to miniature socket. Place unit in circular hole in stock and secure socket with two screws. Pull the socket wire out through the hole in top of stock and solder to the wires leading from the conduits on right side of stock support. Replace circuit indicator cover and secure with the three screws. Attach the battery spring to the hasp and assemble the hasp to the stock. Replace the batteries in their compartments.

(5) Attach the trigger grips to the trigger support. Attach the sling bracket to the trigger grips and secure the sling to the launcher.

(6) Slide the flash deflector over the muzzle of the barrel and secure in place by the mounting clamp.

**d. Disassembly and assembly, launcher M9.** Instructions on disassembly and assembly of launcher M9 will be published later.

**74. INSPECTION. a. Purpose.** Thorough, systematic inspections and prompt repairs are insurance that the weapon will not fail at a critical moment. Inspection discloses the repairs and adjustments necessary to insure proper functioning of the weapon. An inspection should be made of the launcher at delivery and periodically thereafter.

**b. Procedure, launcher M1A1.** (1) Inspect the launcher for its general condition, loose or broken components, chipped paint, bends, dents, or obstructions in the bore.

(2) Test the electric circuit by squeezing the trigger several times. The bulb should light when the trigger is squeezed.

(3) Check for any loose wire connections.

(4) Remove the trigger grips and check for the following:

- (a) Deformed or broken switch contact bar.
- (b) Missing switch contact button.
- (c) Missing bar contact.
- (d) Missing switch contact lower support rivet.
- (e) Loose connections, particularly between switch contact bar and upper switch contact support; and between wires and the upper and the lower switch contact supports.
- (f) Corroded electric contact points.

(5) Remove the circuit indicator cover and check for loose wire connection. Remove the hasp and check for loose connection between wire and stock support.

(6) Remove the batteries and examine for condition. Replace them if cracked, swollen or broken.

(7) Check functioning of tail latch and of trigger spring.

(8) Examine the barrel of the launcher for rust, scale, and dents.

(9) Examine the contact springs to see that they are secure to the mounting clamp and that they are clean and free from rust, paint, and grease.

**c. Procedure, launcher M9.** Instructions on inspection procedure for launcher M9 will be published later.

**75. PREVENTIVE MAINTENANCE.** The following operations will be performed by the using arms:

**a.** Tighten all screws and nuts to prevent their becoming loose in service. This should be done periodically when the weapon is in service. Clean all rust and pitted surfaces with crocus cloth and repaint with lusterless olive-drab enamel.

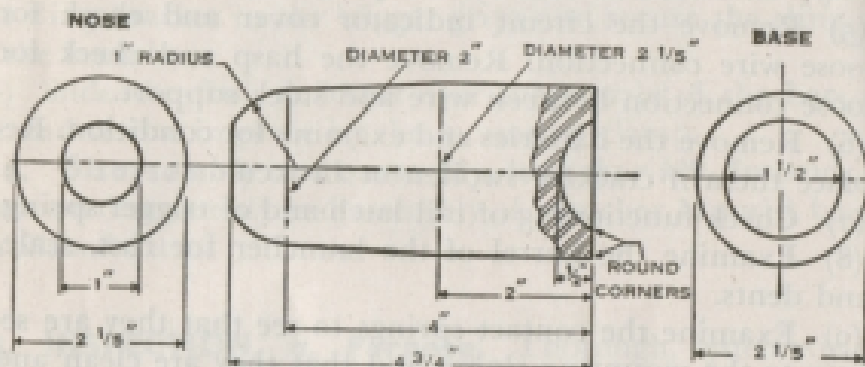
**b.** If the switch contact bar is deformed, it may be bent to its proper shape, but it should be replaced at first opportunity.



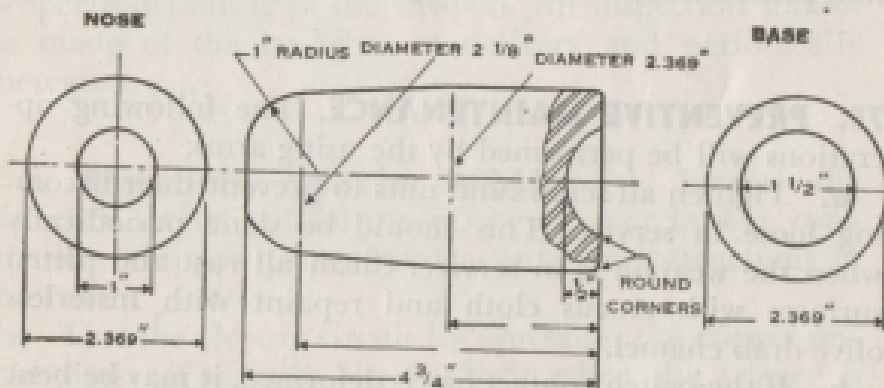
**76. REPAIRS** (fig. 58① and ②). The company armor-artificer or ordnance maintenance personnel will make the following repairs:

- a. Solder all loose or broken soldered connections.
- b. Replace any defective bulbs.
- c. Replace the trigger assembly if the trigger spring is too weak or if trigger stop is missing.

Figure 58. Hardwood punch for removing dents.



① Small dent remover, 2.187 inch diameter.



② Large dent remover, 2.369 inch diameter.

**d.** If tail latch does not function, replace the tail latch spring.

**e.** If trigger grips are broken or cracked allowing moisture to enter, replace grips.

**f.** If electrical contact points are corroded, clean with crocus cloth.

**g.** Remove dents in the barrel by using the tools shown in figure 58. These tools should be improvised.

(1) Drive the small dent remover through the barrel. This will increase the diameter of the dented part of the barrel up to 2.187 inches.

(2) Drive the large dent remover through the barrel. This will bring the diameter of the dented part of the barrel back to the original 2.36 inches.

(3) To restore the original round contour of the barrel, force the dent remover to place under the dents. Using the dent remover as an anvil, hammer the outside surface of the barrel with a ball peen hammer.

**h.** Additional instructions on repair of launcher M9 will be published later.

## **77. CARE AND CLEANING OF LAUNCHER.**

**a. Daily and immediately after firing.** Wet a cloth with rifle bore cleaner and run it through the barrel several times. Then run a dry wiping cloth through until the inside of the tube is clean and dry. Saturate a clean dry wiping cloth with light preservative lubricating oil, wring it out and oil the bore by running the cloth back and forth through the barrel.

**b. Weekly.** Apply one or two drops of light preservative lubricating oil to the tail latch pivot pin.

**c. Prior to firing.** Run a clean, dry wiping cloth through the barrel until, by the appearance of the cloth, it is indicated that the film of oil has been removed from the bore.

**d. External parts.** Rusted, pitted, or chipped exposed metal surfaces should be cleaned with crocus cloth and repainted with lusterless, olive-drab, synthetic enamel. Do not paint the contact springs, flash deflector on launcher M1A1, or that part of tail-latch which makes electrical circuit with rocket complete. To clean wooden stock and grips, wipe with a clean wiping cloth lightly oiled with Type A raw linseed oil. Wipe off thoroughly with a *clean, dry* wiping cloth.

**e. When used in wet weather.** Disassemble the stock and trigger grips and dry all electric contact points and wires with a dry cloth. Clean and oil the rest of the launcher as described above.

**78. UNUSUAL CLIMATIC CONDITIONS.** When operating under unusual conditions such as tropical or arctic climates, severe dust or sand conditions, and near salt water, it is essential that all the precautions listed below should be observed.

**a. Arctic climates.** In temperatures below freezing, but particularly in arctic climates, all operating parts should be kept absolutely free of moisture. The bore of the launcher should be cleaned daily with a clean, dry cloth and oiled with special preservative lubricating oil. The batteries should be removed from the launcher M1A1 and kept warm until just before firing. Carrying batteries in inner pockets will keep them sufficiently warm. Immediately upon bringing indoors, the launcher should be cleaned on the outside and inside with a dry, clean cloth. Remove the grips, clean and dry the launcher again, and oil the bore.

**b. Tropical climates.** (1) When temperature and humidity are high, when salt air is present, or during the rainy season, the launcher should be thoroughly inspected and cleaned daily. The bore should be oiled with medium preservative lubricating oil somewhat more lib-

ually than prescribed in paragraph 77a. Wood parts that have become swollen due to moisture should be shaved off sufficiently to relieve binding. A light coat of raw linseed oil applied at least once a month and well rubbed in with the heel of the hand will help to keep moisture out. Allow oil to soak in for a few hours and then wipe and polish the wood with a dry, clean rag. Care should be taken to see that linseed oil does not get onto electrical contacts as it will gum when dry.

(2) In hot, dry climates where sand and dust are likely to get into the bore, the launcher should be wiped clean daily, inside and out. Oiling of the bore should be done sparingly. In such climates, wood parts are apt to dry out and shrink, and more frequent application of raw linseed oil will help keep wood in condition. During sand or dust storms, the breech and muzzle should be kept covered.

**79. PRECAUTIONS.** a. Steel helmets should be worn by the gunner and loader.

b. For protection from the flash, the gunner should wear gloves and goggles or similar protective equipment such as a cloth wrapped around the hands and a gas mask to shield the face.

c. After the safety pin has been removed, the rocket should be handled with more than ordinary care due to the sensitivity of the fuze.

d. When the propellant is ignited, gases and flames are blown from the breech of the launcher. Therefore, to avoid injury when firing from the prone position, the gunner must place his body so that it is at an angle of  $45^{\circ}$  to the line of aim.

e. The area directly in rear of the launcher for a distance of 30 feet must be clear of personnel or of inflammable material.

f. The rockets should not be fired at temperatures below  $0^{\circ}$  F. nor above  $120^{\circ}$  F.

**g.** At temperatures below  $14^{\circ}$ , the batteries in the launcher M1A1 are so weakened that they will not ignite the propellant charge. When operating in such temperatures, batteries should be removed from the launcher and kept warm until just before firing by carrying them in inside pockets. The spares may be carried in the pockets and switched with the cold ones every hour.

**h.** The rocket as shipped contains a cardboard wad cemented over the Venturi nozzle which prevents entry of moisture or dirt into the propellant charge. Do not use any rocket with a missing cardboard wad. Do not remove the wad.

**i.** During the operations of loading and sighting, the gunner should always keep the muzzle of the launcher pointed toward the target.

**j.** If the rocket fails to fire and if the corrective measures taken (par. 83b) indicate that the fault does not lie in the electrical circuit of the launcher, on command, remove contact wire from contact spring, raise tail latch, and carefully withdraw rocket from the launcher until the safety pin can be reinserted. Reinsert safety pin, remove rocket completely from the launcher and place it to one side for disposal by authorized personnel.

**k.** Always set safety of launcher M9 at SAFE before unloading the launcher.

**l.** No attempt should be made to fire from the launcher M1A1 or M9 the earlier rocket model M6 and M7 identified by the contact ring on the nose (ogive) and a connective wire taped to the outside running from this ring to the tail.

**m.** Boxes containing rockets should not be dropped, thrown, tumbled, or dragged.

**n.** The waterproof seal of the fiber containers should not be broken until the ammunition is about to be used. Items unpacked but not used should be restored to their original condition and packing, and resealed.

**o.** Rockets should be protected against moisture and extremes of temperature. They should not be stored where temperatures exceed 120° F.

**p.** Place rockets in their containers in shaded places. Do not expose rockets to direct rays of the sun until they are ready to be loaded into the launcher.

**q.** Do not allow a rocket to remain in a hot launcher prior to firing.

## SECTION V

### OPERATION

**80. GENERAL.** **a.** Due to the comparatively short sight radius, care should be taken to assume correct firing positions (see par. 86*d*).

**b.** The weapon, especially when the tube becomes heated from firing, has a tendency to shoot high, making it necessary to aim at the bottom of the target.

**c.** Interpolation between the ranges provided on the front sight, estimation of ranges in excess of 300 yards and of windage adversely affect accuracy of fire.

**81. LOADING.** **a.** *During the operations of loading, sighting, and firing, the loader should at all times be to the side of and slightly forward of the breech end of the launcher.*

**b.** The sequence of loading is as follows (fig. 59):

(1) The gunner places launcher on right shoulder and tests the electric circuit by squeezing trigger several times, observing to see that test lamp lights. (There is no test lamp on the launcher M9.)

(2) The gunner takes the prone, sitting, kneeling, or standing position with the launcher on his shoulder. The loader takes a similar position facing the launcher, op-

posite the gunner, and as close to the launcher as possible. The loader should be approximately 1 foot from the launcher and little, if any, to the rear of the gunner.

(3) The gunner commands: LOAD, at the same time dropping his right hand from the trigger and tapping the loader, while supporting the launcher with his left hand. The gunner makes certain the test lamp (on launcher M1A1) is not lighted. He must not squeeze the trigger while launcher is being loaded.

(4) The loader repeats the command, shifting his weight to the left without changing his position on the ground.

(5) The loader grasps a rocket with his left hand, palm up. The rocket is grasped by the tube, with the head of the rocket to the loader's right. The eye of the safety pin is away from the loader and the middle finger of the left hand rests on the eye. (See fig. 59①.)

(6) Simultaneously, the loader grasps the launcher tube and tail latch with his right hand, palm down. His thumb is around the bottom of the tube and his fingers rest on the front portion of the tail latch. Pressing with the fingers, he raises the tail latch. (See fig. 59②.)

(7) The loader inserts the rocket so that the large part of the head is just past the tail latch. He releases the tail latch and with the middle finger of the left hand flips the eye of the pin downward. If the pin does not fall out of the stabilizer tube, he puts his left thumb under the bent portion of the pin and lifts it out.

(8) The loader then slides his left hand back around the fins while he again raises the tail latch with his right hand. He pushes the rocket into the launcher until the notches in the fins line up with the tail latch which is allowed to drop into a notch or notches. To insure a good electrical contact, he gives the rocket a slight rotary twist with the left hand. (See fig. 59③.)

*Figure 59: Sequence of loading.*



ⓐ Loader grasps rocket in left hand.



ⓑ Inserts body of rocket partially into launcher; removes safety pin.





Ⓢ Raises tail latch; pushes rocket completely into launcher.



Ⓢ Removes contact wire from rocket fin.



© Affixes contact wire to contact spring of launcher.



© Taps rocketeer; calls "Up."

(g) The loader pulls the contact wire from the fin and pulling it straight back to uncoil it, fastens it by twisting it around the contact spring. He then taps the gunner and calls "UP." (See fig. 59④, ⑤, and ⑥.)

**82. TO FIRE LAUNCHER.** The launcher is fired by squeezing the trigger with a steady pressure (see par. 86c). There is no slack to be taken up as on a rifle, the actual firing being accomplished by electrical contact. When firing the launcher M9, squeeze the trigger and release it immediately. Do not move the launcher off the target before releasing the trigger.

**83. MALFUNCTIONS AND IMMEDIATE ACTIONS.**

Malfunctions on the launcher may be classified as a failure to load or a failure to fire. Below are some of the more common failures and corrective measures applicable to reduce them in the field.

**a. Failure to load.**

Cause	Corrective measure
Bent tube.	None. Launcher must be replaced.
Bent breech guard.	Straighten with pliers.
Oversize or bent round.	Discard and get new round.
Bent or defective tail latch.	Attempt to straighten latch. If contact cannot be made, the latch will have to be replaced. <i>Caution:</i> Never wedge up forward position of tail latch to get contact.

**b. Failure to fire.** A failure to fire may be the result of weak batteries (in launcher M1A1) or a break in the electrical circuit. The following are some of the more common causes and the remedies:

Cause	Corrective measure
Weak current. Indicator lamp fails to light, launcher fails to fire.	Change batteries. Change batteries. If launcher still fails to fire, inspect and clean trigger mechanism.
Extreme cold (14° to 0°).	Keep batteries warm until just prior to their contemplated use.
Dampness.	Protect launcher from dampness. If wet, dry thoroughly with clean dry cloth; disassemble as neces- sary.
Contact wire not securely con- nected to contact spring.	Attach securely.
Poor contact between tail latch and notches in fins.	Rotate rocket back and forth in order to seat the tail latch firmly on the notch.
Loose or broken parts in trigger mechanism.	Remove trigger grips and check trigger switch contact. If con- tact bar is deformed bend it into correct shape; if broken, turn launcher over to ordnance main- tenance personnel.
Coiled battery spring on hasp fails to contact batteries.	Spread spring coils so that it will make contact.
Loose wires in circuit indicator recess.	Remove circuit indicator cover and tighten wires.
Loose contact wire between bat- tery spring and stock support.	Turn launcher over to ordnance maintenance personnel.

**NOTE:** The above references to batteries apply only to launcher M1A1.

c. **Immediate action.** The procedure for immediate action is shown in the following diagram:

### IMMEDIATE ACTION

Launcher fails to fire

Gunner

Loader

Calls "Misfire."  
Sets safety at SAFE.  
Drops right hand from trigger.  
Taps loader.

Repeats "Misfire."  
Counts to five to allow for a hangfire.  
Disengages contact wire.  
Rotates rocket to insure that tail latch is cutting into notches on tail fins.  
Engages contact wire.  
Taps gunner.  
Calls "UP."

Re-lays and attempts to fire.

If the launcher still fails to fire

Commands: "UNLOAD."  
Drops right hand from trigger.  
Taps loader.

Repeats command UNLOAD.  
Removes contact wire.  
Removes rocket until safety pin hole is exposed.  
Replaces safety pin.  
Removes rocket from launcher.

## SECTION VI

### MARKSMANSHIP

**84. PURPOSE.** The purpose of this section is to provide a guide for the uniform training of individuals in the loading and firing of the rocket launcher M1A1 and M9. Since the rocket launcher normally is operated by two men, the gunner should also be proficient in loading, and the loader should also be proficient in firing. This should be borne in mind during all phases of training.

**85. PHASES OF TRAINING.** Marksmanship training is divided into the following phases:

- a. Preparatory marksmanship.
- b. Range practice.

**86. PREPARATORY MARKSMANSHIP TRAINING. a.**

**Purpose.** (1) The purpose of preparatory marksmanship training is to teach the soldier the essentials of shooting and to develop fixed and correct shooting habits before he undertakes range practice.

(2) To become proficient in the firing of the rocket launcher, the rocket gunner must be thoroughly trained in the following essentials:

- (a) Correct sighting and aiming.
- (b) Correct trigger squeeze.
- (c) Correct positions.
- (d) Knowledge of range estimation.
- (e) Knowledge of speed estimation.
- (f) Knowledge of lead estimation.

(3) In training, the sequence in which these subjects are listed should be followed. Instruction should be thorough, and each individual should be carefully supervised dur-

ing all stages of training. All errors should be corrected immediately. The soldier must be impressed with the importance of exactness in every detail.

(4) The practice antitank rocket, 2.36-inch, M7A1 or M7A3 *only* will be used during preparatory exercises. The practice rounds are fully loaded with a propellant charge. Severe burns or injuries from the propellant or from the projectile itself may result unless extreme vigilance is maintained to insure that no batteries are in the launcher during any instruction in positions in which the loader serves the piece.

(5) For loading practice, it is advisable to make up dummy rounds from M7A1 or M7A3 rockets which have been fired and recovered.

**b. Sighting and aiming** (fig. 59). (1) **PROPER SIGHT PICTURE.** The proper sight picture for the launcher is no different from that for other weapons in that the hold is on the bottom of the target. The importance of proper sight pictures cannot be overemphasized. No sight picture can be obtained with launcher M1A1 beyond 300 yards. Elevation for ranges between 300 and 650 yards must be estimated. In all cases, the eyes should be kept in line with the sights. At all ranges, the front sight stud should be aligned midway of the peep sight as shown in figure 60.

(2) **SIGHTING AND AIMING EXERCISES.** (a) A launcher is placed on a rest and pointed at a blank sheet of paper mounted on a box which is 1,000 inches from the rest. Without touching the launcher or rest, the instructor takes a prone position and looks through the sight. He directs the marker, by command or improvised signal, to move the target until it is in correct alignment with the sight. (The target should be a small silhouette, approximately 6 inches in length with height in proportion, and forming the general outline of a tank.) He then commands: **HOLD** to the marker. The instructor moves

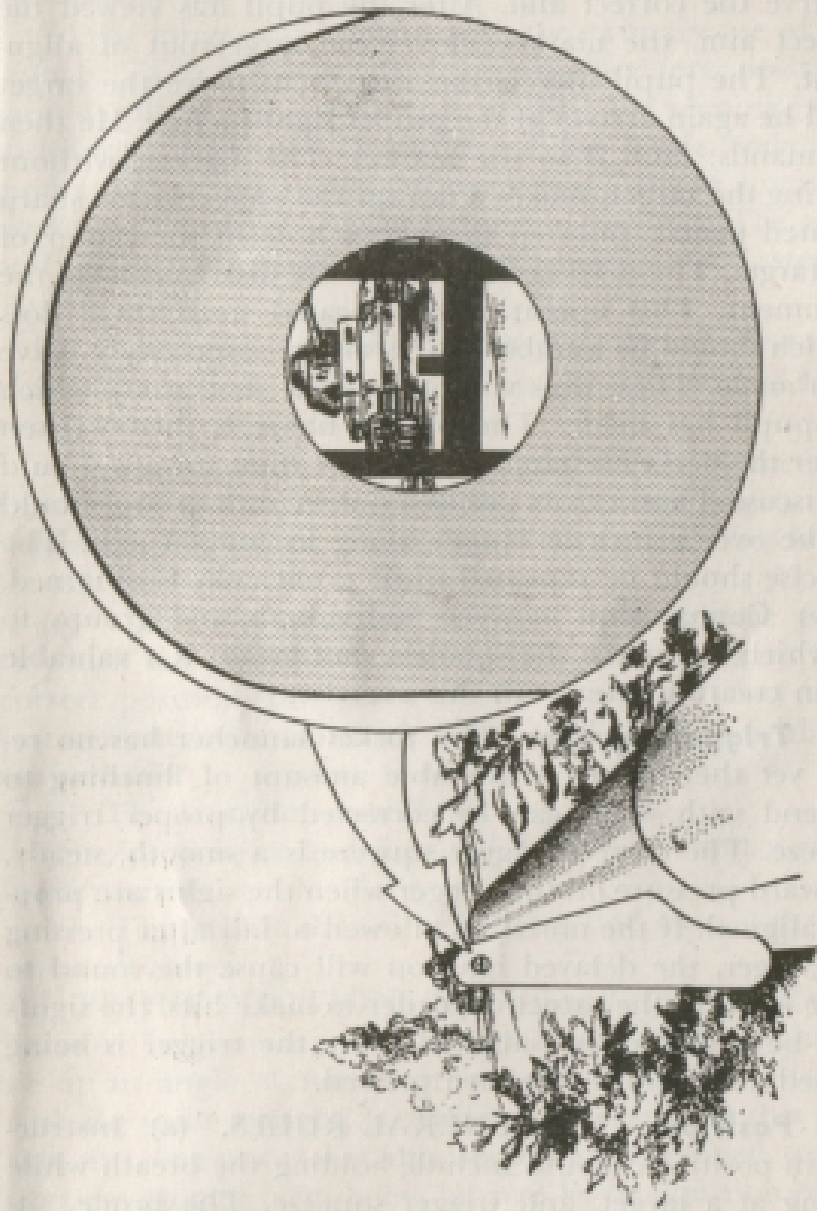


Figure 60. Proper sight picture, launcher Mr. A.



away from the launcher without disturbing the sights, and directs the pupil to look through the sights in order to observe the correct aim. After the pupil has viewed the correct aim, the marker moves the target out of alignment. The pupil directs the marker to move the target until he again arrives at the proper sight picture. He then commands: **HOLD** to the marker. The marker, without moving the target, makes a dot on the paper with a sharp pointed pencil, inserted through a hole in the center of the target. The marker then moves the disk to change the alignment. This operation is repeated until three dots (which should be numbered 1, 2, and 3, respectively) have been made. These dots will outline the shot group which the pupil has made. The pupil's name is then written under the dots. The size and shape of these groups should be discussed and errors pointed out. A shot group should not be over 1 inch in length along its longest axis. The exercise should be repeated until proficiency is obtained.

(b) Competition between individuals and groups to see which can make the smallest shot group is a valuable aid in creating interest in this exercise.

**c. Trigger squeeze.** The rocket launcher has no recoil, yet there is a considerable amount of flinching to contend with. This can be corrected by proper trigger squeeze. The correct trigger squeeze is a smooth, steady, rearward pressure on the trigger when the sights are properly aligned. If the muzzle is allowed to fall after pressing the trigger, the delayed ignition will cause the round to strike short of the target. In order to make hits, the sights must be kept properly aligned while the trigger is being pressed and *after* it has been pressed.

**d. Positions.** (1) **GENERAL RULES.** (a) Instruction in positions should include holding the breath while aiming at a target, and trigger squeeze. The prone, sitting, kneeling, and standing positions are generally similar to those used with other shoulder weapons. The exact

etails of a position for any individual will depend largely on his own conformation. In any case, the gunner should be comfortable, relaxed, and steady.

(b) At ranges up to 300 yards, the primary use of the launcher is to fire at *moving* targets. Therefore, positions should afford the greatest flexibility in keeping with steadiness. To insure flexibility of the firer's body, the gunner should not rest his elbows when firing at a moving target *except when he is in the prone position*. The arms and upper body should be free to permit smooth, steady, easy swinging.

(c) When firing at stationary targets, the steadiest position is the best. The firer *should* rest his elbows and body to insure the greatest steadiness.

(d) Although offering a low silhouette, the prone position is not well adapted to firing at moving targets, and where possible one of the other positions should be chosen for this purpose.

(e) Upon assuming any position, there is some point to which the launcher naturally falls without effort. In a correct position, this point will be the target. Any readjustment necessary to cause this should be made with the entire body.

(f) The launcher should not be canted.

(g) All practice and firing will be done from a right-hand position.

(h) The muzzle should be kept up and toward the target at all times.

(2) PRONE POSITION (fig. 61Ⓐ and Ⓑ). (a) *Rocket Gunner*. In assuming the prone position, the body should lie at an angle of not less than  $45^{\circ}$  to the line of aim, with the spine straight. In tracking a target from this position, it is necessary that this angle be maintained to prevent the gunner from being burned by the ignition of the propellant. The right leg should be directly on a line running through the gunner's right hip and right shoulder,

the left leg must be carried to the left as far as possible with comfort, and both heels should be flat on the ground. The elbows should be well under the body, the left hand should be below hand-grip, and the stock should be placed firmly against the shoulder. The head should be placed so that the eyes line up with the sights and so that the head is as steady and comfortable as possible.

(b) *Loader*. The loader places himself flat on the ground, resting on both elbows and at right angles to the line of aim. He should be close enough to the gunner to communicate with him and at the same time serve the piece. The loader should be opposite the gunner's right shoulder. While tracking, the loader must move about to conform with the movements of the gunner in order to prevent burns and to serve the piece effectively.

(3) **SITTING POSITION** (fig. 62). (a) *Rocket Gunner*. There are two satisfactory positions. The first position described is preferable, as it permits quicker and easier movement of the body in tracking.

1. *Sitting position No. 1* (fig. 62⊙). The gunner should sit at half right face from the target, legs crossed and resting on the heels, and body leaning slightly forward from the hips with the back straight. The left elbow should be under the piece, right elbow held as high as comfortable in order to form a pocket for the stock, neither elbow rested. The head should be placed so that the right eye lines up with the sights. The left hand should be below the hand grip, and the right hand grasping the hand grip. All tracking movements should be from the hips up unless it becomes necessary for the firer to change his entire position. From this sitting position, the gunner will have a traverse of approximately  $90^{\circ}$  without moving his position.

Figure 61. Prone position.



© Front view.



© Rear view.

2. *Sitting position No. 2* (fig. 62Ⓢ). The principal difference between this and sitting position No. 1 is, that instead of the gunner's legs being crossed, the feet are well apart and are braced with the heels dug into the ground in the conventional rifle position and with the elbows resting on the knees, unless tracking a target. The disadvantage of this position is that in firing downhill on a moving target, the elbows and knees cause interference and restrict the traverse.

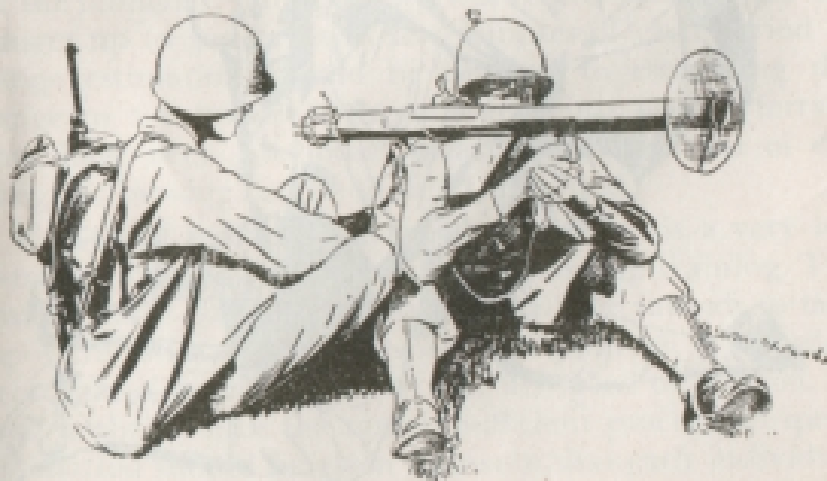
(b) *Loader*. The loader takes up a sitting position with legs crossed, right leg over left, at right angles to the line of aim opposite the gunner's right shoulder. He should be close enough to the gunner in position No. 1 so that the gunner's right knee may rest upon the loader's right leg. The loader must move about to conform with the movements of the gunner while tracking in order to prevent burns and effectively serve the piece. If the gunner is in position No. 2, his right knee will not rest on the loader's right knee.

(4) **KNEELING POSITION** (fig. 63). (a) *Rocket Gunner*. The kneeling position for use with the launcher is somewhat similar to the conventional antiaircraft position for use with the rifle. The gunner kneels down on his right knee with the buttocks well up and away from the right heel, the left leg is pointed toward the target, the left foot is at right angles to and opposite the right knee, and the left leg forms a right angle to the ground. The body is held erect with the left elbow under the piece and the right hand grasping the hand grip, supported by the left hand, right elbow as high as possible to form a pocket for the stock. In this position, traversing is done by moving the body from the ground up. With very little practice, a gunner should be able to have a traverse of approximately 180°.

Figure 62. Sitting position.



Ⓒ Erect, to permit tracking.



Ⓒ Elbows resting on knees.

(b) *Loader.* The loader places himself in a kneeling position with one or both knees on the ground and at right angles to the line of aim. He should be close enough to the gunner to communicate with him, and at the same time serve the piece. The loader should be opposite the gunner's right shoulder. While tracking, the loader must move about to conform with the movements of the gunner in order to avoid burns and effectively serve the piece.



Figure 63. *Kneeling position.*

(5) **STANDING POSITION.** (a) *Rocket Gunner.* The standing position is similar to the conventional standing position used with the rifle. The gunner stands half-faced to the right with his feet from 1 foot to 2 feet apart, body erect and well balanced. The left elbow is comfortably under the launcher. The right elbow should be raised as far as possible in order to form a pocket for the stock with the right hand grasping the handgrip and steadied by the left hand. In this position, traversing is done by moving the body from the ankles up. (See fig. 59@.)

(b) *Loader.* The loader takes up a standing position at right angles to the line of fire and opposite the gunner's right shoulder. He should be close enough to the gunner to serve the piece. While tracking, the loader must move about to conform with the movements of the gunner in order to prevent burns and to serve the piece effectively.

**e. Range estimation.** Due to the trajectory of the weapon, accurate range estimation is vital. It is unnecessary to practice or instruct in estimation of ranges in excess of 650 yards because of the limited range and accuracy of the launcher, but much work is required at the shorter ranges up to 300 yards. A few minutes of each period of range estimation should be devoted to estimating the range to a number of prominent points on the terrain that have been previously measured. Estimation of the range to moving targets should be stressed.

**f. Speed estimation.** Speed estimation is a very important phase of preparatory marksmanship training. The gunner must base the number of leads he intends to take upon his estimation of the speed of the target. It is readily seen that if he makes an error in his speed estimation, he will probably miss the target. Sufficient practice in speed estimation should be given to insure that each individual is proficient. This practice should be secured as follows:

- (1) Have a vehicle pass in front of the men undergoing instruction at announced speeds and at various ranges so

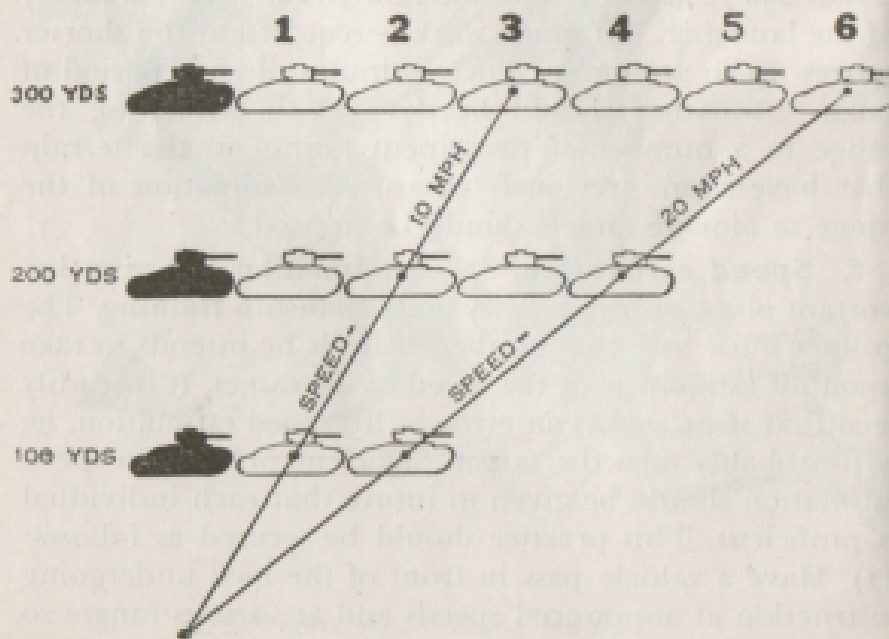


that the men will get a mental picture of the various speeds. Then have the vehicle move about at unannounced speeds and have each man write his estimate of the speeds. Then announce the correct speeds. (Because of the fact that tanks seldom move cross-country in excess of 20 miles per hour, the speed of the vehicle should not exceed that rate.)

(2) Repeat this procedure until the instructor is satisfied that all men can accurately estimate speeds.

**g. Lead estimation** (fig. 64). In order to hit a moving target, it is necessary to aim an appropriate distance ahead of it and on its projected path of movement so that the target and the projectile will meet. The length of a lead is the length of the target as it appears to the firer. Leads must be applied in all firing at moving targets except when the target is at extremely close range (25 yards) or when it is *directly* approaching or receding from the gun-

Figure 64. Lead diagram.



er. The leads indicated in figure 64 should be memorized.

**h. Determination of leads.** (1) The number of leads necessary to engage any target depends upon the speed of the target, the range of the target, the time of flight of the projectile, and the direction of travel of the target with respect to the line of fire. Practice may be secured by placing targets at known ranges and marking off leads by placing stakes. This visually demonstrates to the men the actual application of the lead. Targets of different lengths should be utilized.

(2) Practice on still targets should be followed by practice with moving targets. Have a vehicle pass in front of the men at an unannounced range, moving at varying speeds and with frequent changes in direction. Require each man to demonstrate his ability to estimate range and speed and to apply the lead table.

**37. RANGE PRACTICE. a. General.** Range practice should be initiated immediately after the completion of the preparatory training. No man will be permitted to fire until he has satisfactorily completed the preparatory marksmanship training.

**b. Range personnel.** An officer in charge of firing will be designated by the responsible commander. He will be present during all firing and will be responsible for safety precautions.

**c. Safety precautions.** The following safety precautions will be observed:

(1) Danger flags will be displayed at prominent positions on the range during firing.

(2) Firing will not begin on any range until the officer in charge has ascertained that the range is clear and has given the command to fire.

(3) At least one officer will be present at all firing.

(4) No launcher will be removed from the firing line until an officer orders it back.

(5) All misfires will be unloaded only upon command (par. 79f).

(6) All loading and unloading will be executed upon the firing line, with muzzles directed toward the target and not pointed toward the ground.

(7) Care should be taken to avoid direct exposure of ammunition to the sun.

(8) Equipment must be inspected in the prescribed manner before firing.

(9) The firing line and the ready line should be at least 20 yards apart in order not to expose personnel to back blast.

(10) A noncommissioned officer should be designated to count the number of shots fired and number of explosions when using the high explosive rocket M6A1 or M6A3 so that duds may be accounted for.

(11) In the event that a rocket fails to explode (dud), it will be destroyed in place by competent personnel. For information on disposal of duds, see TM 9-1900.

(12) Ammunition will be issued only on the ready line.

(13) Rocket gunner should wear gloves and goggles.

(14) For additional safety precautions, see AR 750-10.

**d. Firing at stationary targets.** (1) The target used for stationary firing should be at least 10 feet square. When firing with the high-explosive rocket M6A1 or M6A3, the target should be either of wood or metal, heavily constructed, since a cloth or paper target will not cause the round to explode.

(2) The following procedure will be adhered to while firing at stationary targets: a commissioned officer will be in charge of the firing line. Additional officers or non-commissioned officers to assist in the supervision of the firing will be required in the ratio of one to every five firing points. When called to the firing line, the gunner and loader will come forward, accompanied by a qualified coach. The gunner immediately takes his position and the

loader opens the rocket container. The officer in charge of firing commands: **LOAD**. The loader loads the launcher and gives the signal up. When all teams have signified that they are ready to fire, the officer has each gunner fire *separately* upon his command. When the command is given for an individual team to fire, the loader taps the gunner and calls "Up," and the gunner fires. When the order has completed firing, it is ordered back by the officer in charge, and a new order is called up. Any round that misfires is given immediate action. (See pars. 79j, 83b and c.)

**e. Firing at moving targets.** (1) The moving target should be 15 to 18 feet long by 6 to 8 feet high, and should travel up to speeds of 20 mph. The firing and the movement of the targets must be closely coordinated to avoid any undue delays on the firing line. For this reason, means of communication should be provided between the towing vehicle and the firing line.

(2) The following procedure should be adhered to while firing on moving targets: for the purpose of control, not more than four gunners should fire on any one order. The teams, accompanied by their coaches immediately take up positions from which they are going to fire. When all have their positions, the officer in charge will give the command: **LOAD**. The loaders then load the launchers and give the signal up. When all teams have signaled up, the officer in charge will give the command: **TOW TARGET**. Upon this command, the loaders tap the gunners and call "Up," and the gunners then fire at will. Any gunners having a misfire will fire on a later order. When the target has stopped moving, the officer in charge gives the command: **UNLOAD**. Upon this command, the loader removes the contact wire from the contact spring, raises the latch, removes the rocket and replaces the safety pin. When all launchers are clear, the order will be ordered back and the next order called up.

**f. Firing schedule.** (1) A recommended course of firing follows. The firing at stationary targets having been completed, moving-target firing at the shorter ranges is then commenced. Targets should be moved both from right to left and from left to right, and each gunner should be required to fire at the target at least once for each direction of movement. (See par. 46b (4) for a plan of a moving target range.)

*AT STATIONARY TARGETS<sup>3</sup>*

Position	Range	Number of shots
Standing.....	100	1
Prone.....	200	1
Sitting.....	300	1

*AT MOVING TARGETS<sup>3</sup>*

Position	Range	Number of shots
Standing.....	100	1
Sitting.....	100	1
Standing.....	200	1
From pit fox hole or pit type emplacement.	200	1
Prone.....	200	1
Kneeling.....	300	1
Sitting.....	300	1
Total.....		10

<sup>3</sup>Ammunition allowances may permit individuals to fire only a part of the above firing schedules. Training in high-angle fire is not prescribed, as it must be done entirely by estimation.



(2) It may be necessary to train some individuals with less than ten rounds. Men who will probably not be called upon to use the rocket launcher often can be satisfactorily trained with five rounds or less. A recommended course of firing follows:

*AT STATIONARY TARGETS*

Position	Range	Number of shots
Standing.....	100	1
Kneeling.....	200	1

*AT MOVING TARGETS*

Position	Range	Number of shots
Standing.....	200	1
Sitting.....	200	1
Kneeling.....	300	1
Total.....		5

**88. TRAINING SCHEDULE.** A suggested training schedule follows. This should be used as a guide only, but the time available for instruction should be fitted to this schedule as closely as possible.

Period	Time allotted (percent of total)	Subject	Text reference	Area	Equipment	Remarks
1	10%	Introduction—general; Characteristics, pur- pose, and use. Nomen- clature. Ammunition. Fire and its effect. Functioning.	FM 23-30, ch. 3, secs. I, II, III, and V.	Indoors or outdoors.	1 launcher, M1A1 or M9. 1 rocket, AT, HE, 2.36-inch, M6A1 or M6A3. 1 rocket, AT, practice, M7A1 or M7A3. 25 launchers, MA1A or M9. 25 rockets, AT, practice, M7A1 or M7A3.	1 launcher (with- out batteries) and 1 rocket per 2 men.
2	10%	Operation. Maintenance. Sight pictures.	FM 23-30, ch. 3, secs. IV, V, and VI.	Indoors or outdoors.	25 rockets, AT, practice, M7A1 or M7A3. 1 rocket, AT, HE, 2.36-inch, M6A1 or M6A3 Charts. 24 launchers, M1A1 or M9.	1 rocket per 2 men. 1 HE rocket for in- structor only.
3	10%	Sighting and aiming ex- ercises. Loading and unloading.	FM 23-30, ch. 3, secs. V and VI.	Outdoors.	24 rockets, AT, practice, M7A1 or M7A3. 24 launchers, M1A1 or M9. 24 silhouette targets. 100 sheets, plain white paper. 100 thumbtacks. 24 pencils. 1 launcher, M1A1 or M9. 1 rocket, AT, practice, M7A1 or M7A3.	Demonstration only. Check all launchers on field and re- move all bat- teries. Both members of team should be trained in this step.

4	10%	Standing. Sitting. Kneeling. Prone.	FM 23-30, ch. 3, sec. VI.	Outdoors.	24 launchers, M1A1 or M19, 24 rockets, practice, M7A1 or M7A3, 8 targets.	1 launcher and 1 rocket per 2 men. 2 targets per squad.
5	10%	Range estimation. Speed estimation. Dry firing on moving targets.	FM 23-15, par. 170. FM 23-30, ch. 3, sec. VI.	Outdoors.	Stakes or flags, 1 vehicle, 6 stakes 6 feet long, 1 vehicle.	Men to bring note- book and pencil. Some means of visibly marking stakes should be provided, for ex- ample, red stake, green stake. Notebooks and pencils.
6	50%	Range practice.	FM 23-30, ch. 3, sec. VI.	Outdoors.	Suitable stationary targets. Suitable moving targets.	2 hours on station- ary targets. 4 hours on moving targets. See FM 23-30 for lay-out for moving target range.



## SECTION VII

### TACTICAL EMPLOYMENT

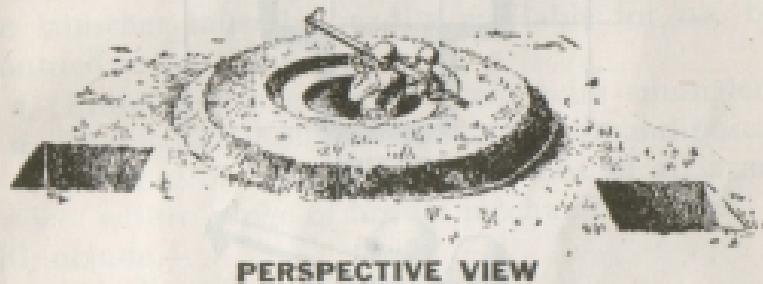
**89. GENERAL.** The tactical employment of the rocket is governed by its capabilities and limitations. It has its principal function as a defensive antimechanized weapon, although tank destroyer personnel, motorized reconnaissance units, and other specially organized groups may use it offensively in many situations. The rocket does not supplant but supplements the antitank rifle grenade MgA1 and such other antimechanized weapons as may be issued to any unit.

**90. OFFENSIVE ACTION.** The rocket is an effective weapon for use by raiding groups, tank hunting parties, reconnaissance elements, and in the attack of towns and villages. The rocket is especially effective in attacks on vehicular bivouacs, halted or disabled vehicles, and for use in ambushes. It is capable of delivering harassing fire against an area target up to ranges as great as 650 yards. However, ammunition must be conserved in order that the rocket may perform its primary mission — defensive action against mechanized forces. Being highly mobile, the anti-tank rocket is a valuable weapon with any landing force which may expect to encounter pillbox or mechanized defenses. In such operations, specially organized teams should accompany the leading elements of the landing force.

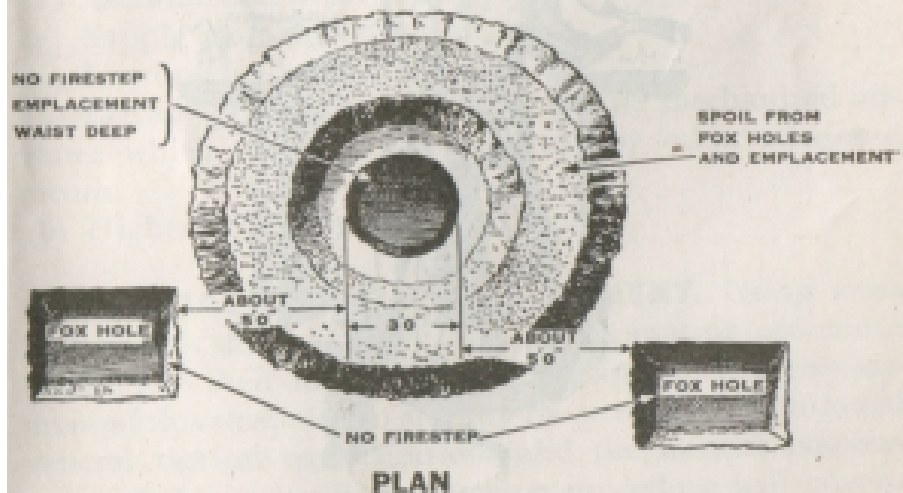
**91. DEFENSIVE ACTION.** For the close-in defense of units and installations, the rocket is a highly mobile and effective weapon. Normally, rocket gunners and loaders

will be designated from among ammunition bearers, truck drivers, clerks, and other personnel. However, when required by the situation, all launchers must be manned by any available personnel who have been trained in their use. Whenever time permits, rocket teams will be assigned a definite place in the antimechanized defense of the weapon, unit, or installation. If natural cover against mechanized attack is not available, pit type or pit fox hole type emplacements should be dug for the rocket teams. (See fig. 65.) In case of surprise attack by hostile mechanized forces, gunners will direct their fire against the nearest

Figure 65. Emplacements for rocket team.



PERSPECTIVE VIEW



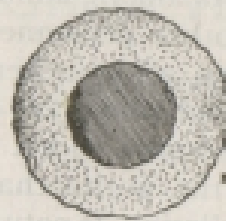
PLAN

© Pit fox hole type.

hostile vehicle. In the absence of orders or standing operating procedure, gunners will maneuver so as to place themselves in the most favorable position to engage and destroy hostile mechanized vehicles in the immediate vicinity which constitute a threat to the unit or installation. The normal tactical employment of the rocket as a defensive weapon is enumerated below:

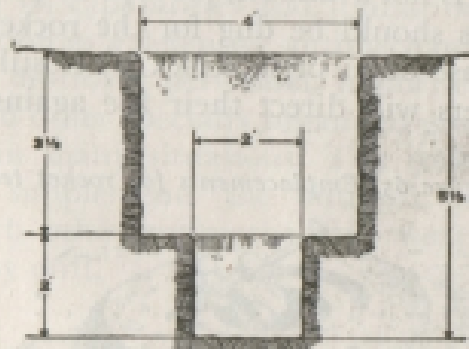
- a. Close-in defense of crew-served weapons.
- b. Protection of motorized columns on the march and at temporary halts. Under these conditions, it must be noted that it is not desirable to fire rockets from a vehicle, because of the blast effect of the propellant on occupants of the vehicle, its cargo, and the vehicle itself. In all cases the launcher must be readily available for use by dismounted action (par. 93).
- c. Protection of mine fields and wire entanglements.
- d. Protection of observation and command posts.
- e. Defense of rear area installations of all arms and services within range of hostile mechanized forces. These will include —
  - (1) Train bivouacs.
  - (2) Ammunition distributing points.
  - (3) Supply installations of all types.
  - (4) Landing fields and airdromes.
  - (5) Critical points on a route of hostile mechanized advance which may not be protected by other adequate means.
  - (6) Higher headquarters installations.

**92. SPECIAL TACTICAL EMPLOYMENT.** Using arms and services should develop standing operating procedure peculiar to their needs for the most appropriate employment of this weapon. To amplify the previously mentioned general tactical considerations and the normal employment of the rocket, the following procedure will govern when applicable:



NOTE:  
SPOIL  
REMOVED

PLAN



SECTION



© Pit type.

must be an incident and emergency and that it will be completely available for emergency action. Only under the most favorable conditions or in instances of exceptional urgency will vehicles be used from a vehicle.

**4. Policies of their business and how area health.** (a) Traffic business and area health are normally provided by a program of close cooperation with the various agencies having jurisdiction. The tasks required by various agencies, emergency work done, area personnel, and when about primary duties should be assigned a definite role by the local mechanical division. This will require detailed instructions, close coordination, and active cooperation on the part of the personnel charged with these duties. (b) Wherever possible, working agreements should be developed so that the vehicle repair and emergency personnel's responsibilities and preparedness for work with the mechanical division and other fire departments should be clearly defined. It is suggested to meet these various agencies or members of such any department.

## SECTION VIII

### GENERAL INFORMATION

**11. METHODS OF TRANSPORTING LAWNMOWERS AND LAWNMOWERS.** Proper maintenance of carrying equipment, proper use of hookups, and correct use of the carrying the load on various types of vehicles. It may be suspended from the back of the truck, a trailer and other suitable ways or more. In the truck that the load may be carried across the back of ground using the rear end. All methods of transporting the

4. **Personnel.** Whether or not all units have had an opportunity to fire the various launchers, they should have at least received instruction in the operation, care, and maintenance of the weapons, together with formal drill concerning its capabilities and limitations. Subordinate leaders will insure that all available personnel are promptly employed as they are.

5. **Use of crew-served weapons.** (1) The firing and use of crew-served weapons are particularly valuable in mechanized attack. Crew-served weapons which have difficulty in tracking rapidly moving targets or which under fire are on the level of the front-line mechanized units should be used in the manner provided in the above and given to rifle companies and other groups. The various launchers and weapons are available in abundance wherever for the service of the group should be employed in platoons and other groups when units engage in mechanized attack. A daily inspection of equipment of a crew-served vehicle should be maintained, and positions to be occupied by personnel and other groups should be prepared as soon as their primary duties will permit.

(2) Since designated other groups will normally function in their primary duties and a status of maintenance as well as become involved, and effective and timely training areas must be established to insure that groups may be able to receive their ammunition and equipment and carry out their assigned positions.

6. **Use of motorized vehicles.** Vehicles carrying launchers and rockets should be distributed throughout the column. It is also to function as opportunity through a mechanized attack by increasing speed in the direction of travel should the use of an advance to escape a mechanized attack to use provided, vehicles should be driven to any available road and other groups and personnel may be moved from the vehicle within effective range by dismounted action. Rocket and ground equipment

rockets and launchers in vehicles must permit instant availability for dismounted action. Rockets may be carried in vehicles in the original packing case, or containers of not more than three rounds may be taped or strapped together. The M6 ammunition bag is suitable for carrying rockets when dismounted, the maximum load being three rounds per bag. Ammunition must be protected from dirt and moisture and secured against excessive shocks which might cause detonation.

**94. SECONDARY EMPLOYMENT** (fig. 66). In addition to its use as a projectile when fired from the launcher, the rocket may be prepared for firing electrically and used as an improvised antitank mine as follows:

a. Remove the rocket from its container. With the top (open) end of the empty container resting on the ground or other surface, punch a hole in the bottom. Insert the ends of the actuating wires in the hole. Twisted-pair field telephone wire is suitable for use as actuating wires. Lift the container with one hand and push the wires through until they extend about 8 inches beyond the open end of the container. This extension allows sufficient leeway to connect the actuating wires to the rocket. A coiled contact wire is lightly taped to one of the rocket fins. Remove this wire from the fin and connect it to one of the actuating wires. Connect the other actuating wire to the wire which is soldered to one of the rocket fins, by wrapping it tightly around the soldered connection. Slide the rocket, fins first, partially into the container, remove the safety pin, and then slide the rocket down all the way. Place a piece of the adhesive container seal over the exit of the actuating wires to help keep out moisture. Close the space between the open end of the container and the rocket head with the remainder of the container seal, for the same reason.

b. Place the assembly in a hole about 2 feet deep, with nose up, or horizontally in the side of a bank or cut, prop-

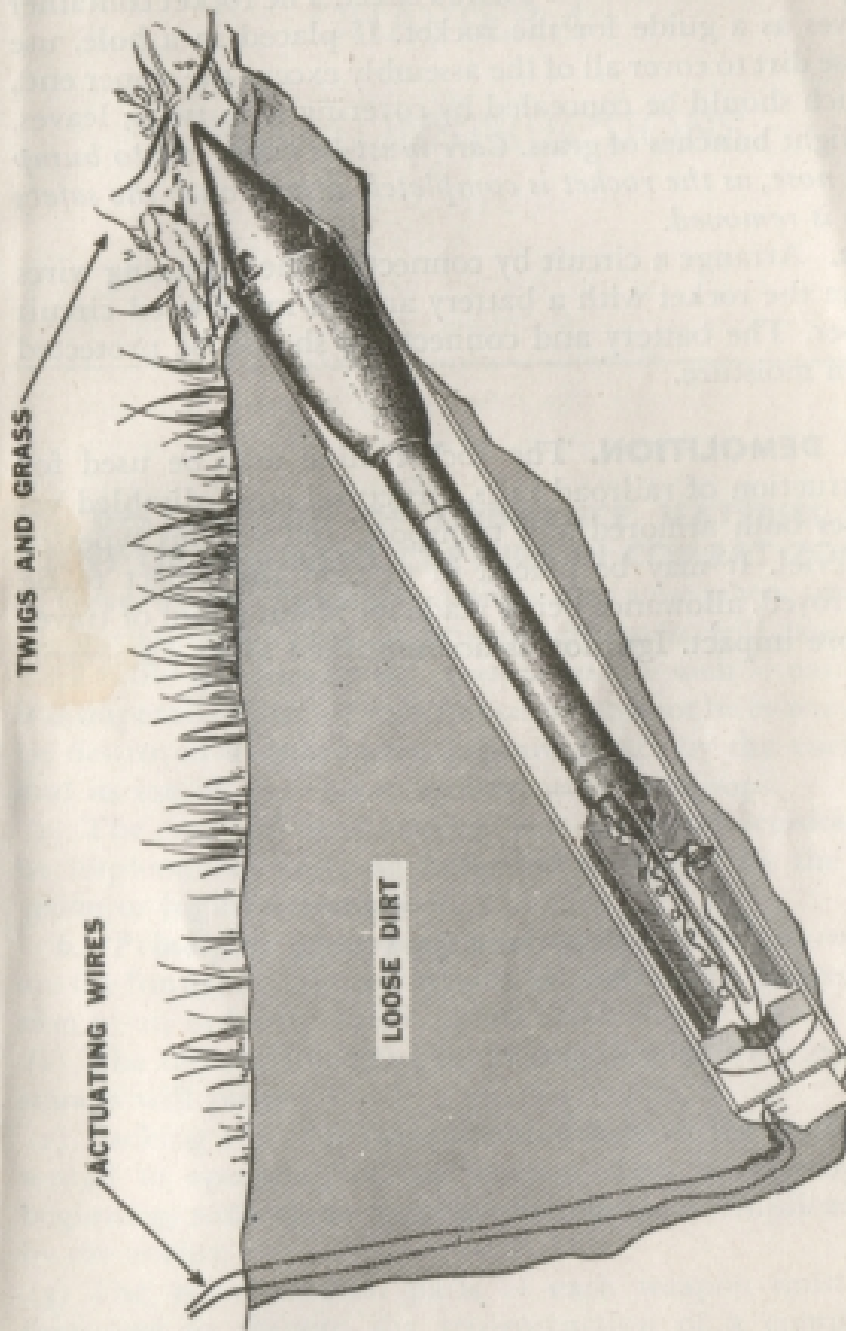


Figure 66. Rocket used as antitank mine.



erly sited to achieve the desired effect. The rocket container serves as a guide for the rocket. If placed in a hole, use loose dirt to cover all of the assembly except the upper end, which should be concealed by covering with twigs, leaves, or light bunches of grass. *Care must be taken not to bump the nose, as the rocket is completely armed once the safety pin is removed.*

c. Arrange a circuit by connecting the actuating wires from the rocket with a battery and an improvised circuit closer. The battery and connections should be protected from moisture.

**95. DEMOLITION.** The rocket mine may be used for destruction of railroad rails, structural steel, disabled vehicles both armored and transport, and various types of matériel. It may be placed in or near the object to be destroyed, allowance being made for about a foot of travel before impact. Ignition is accomplished as in paragraph 94a.

## CHAPTER 4

### SPECIAL INSTRUCTIONS

---

#### **96. DESTRUCTION OF ORDNANCE MATÉRIEL IN EVENT OF IMMINENT CAPTURE IN COMBAT ZONE.**

**a. General.** (1) Tactical situations may arise when, owing to limitations of time or transportation, it will become impossible to evacuate all equipment. In such situations it is imperative that all matériel which cannot be evacuated be destroyed to prevent its capture intact by the enemy, and its use by the enemy against our own troops.

(2) The destruction of matériel is a command decision to be implemented only on authority delegated by the division or higher commander.

**b. Principles governing destruction.** The following are the fundamental principles to be observed in the execution of an order to destroy small arms:

(1) The destruction must be as complete as the circumstances will permit.

(2) Lacking time for complete destruction, the parts essential to operation of the weapon must be destroyed, beginning with those parts most difficult of duplication by the enemy.

(3) The same essential parts of each weapon must be destroyed to prevent the reconstruction of a complete weapon from several damaged parts.

**c. Training.** The training of individuals before they reach the combat zone will be such as to insure their ability to destroy quickly and adequately the weapons with which they are armed in an established and uniform sequence based on the principles stated above. Training will not involve the actual destruction of matériel.

**d. Method.** (1) **GRENADES.** Incendiary grenades M14 are useful in igniting the matériel. Affix the grenade to top of the stack, pull the pin with cord or wire attached thereto, and take cover.

(a) When destroying unpacked grenades, stack them in small piles. Stack or pile most of the available gasoline in cans and drums around the ammunition. Throw onto the pile all available inflammable material such as rags, scrap wood, and brush. Pour the remaining gasoline over the pile. Sufficient inflammable material must be used to insure a very hot fire. Ignite the gasoline and take cover.

(b) In destroying packed grenades, stack the boxes in small piles. Cover with all available inflammable materials, such as rags, scrap wood, brush, and gasoline in drums or cans. Pour gasoline over the pile. Ignite the gasoline and take cover.

(2) **ROCKETS.** Rockets can be destroyed by sympathetic detonation, using TNT. Place the boxes of the packed rockets so that the nose (ogive) of the rockets is down. Unpacked rockets will be placed in vertical position in a recess between boxes with nose (ogive) down. Place TNT charges between the stacks. Use a minimum of 1 pound of TNT per seven or eight rockets. Detonate all TNT charges simultaneously from cover.

APPENDIX  
LIST OF REFERENCES

---

2.36-inch, AT Rocket Launcher M1A1 . . . . .	TM 9-294
Ammunition, General . . . . .	TM 9-1900
Grenades, Hand and Rifle . . . . .	TM 9-1985
Range Regulations for Firing Ammunition for Training and Target Practice . . . . .	AR 750-10
Qualification in Arms and Ammunition Train- ing Allowances . . . . .	AR 775-10

## INDEX

	<i>Paragraph</i>	<i>Page</i>
Accessories, rifle grenades.....	30	60
Advice to instructors:		
Hand grenades .....	25-28	50
Rifle grenades .....	59-61	117
Rocket launcher .....	88	177
Alignment of grenade launchers.....	31	70
Ammunition carrying bag.....	30, 71	60, 142
Antitank rifle grenade.....	29	55
Cartridges, rifle grenade.....	30	60
Chemical hand grenades.....	1, 4, 5	1, 5, 17
Cleaning:		
Rifle grenade launcher.....	30	60
Rocket launcher .....	77	149
Combat training, hand grenades.....	12-16	35
Courts, hand grenade.....	8-11	31
Courses:		
Grenade assault .....	14, 15	39, 40
Moving target .....	44	87
Stationary target .....	42	85
Destruction of matériel.....	96	189
Detonators .....	3	3
Disassembly and assembly, rocket launcher..	73	143
Duds .....	24	47
Equipment:		
Antipersonnel .....	48	93
Antitank .....	36	76
Hand grenade .....	28	53

	<i>Paragraph</i>	<i>Page</i>
<b>Exercises:</b>		
Sequence of loading and firing rifle grenades .....	32	72
Sighting and aiming antipersonnel.....	52	107
Sighting and aiming antitank.....	39	79
Field target firing.....	45	87
Field training .....	16	41
Fillers, hand grenade.....	2	1
Fuzes .....	3, 22	3-45
<b>Grenades, hand:</b>		
Characteristics .....	4	5
Types .....	1	1
Grenade projection adapter.....	30	60
Grenades, rifle, types, nomenclature, and characteristics .....	29	55
<b>Identification and markings:</b>		
Hand grenades .....	4	5
Rifle grenades .....	29	55
Rockets .....	70	139
Immediate actions for rocket launcher.....	83	158
Inspection of rocket launcher.....	74	146
Launchers .....	30, 62	60, 120
Lead estimation for rocket launcher.....	86	161
Live grenade throwing.....	14	39
Loading rocket launcher.....	81	153
Maintenance of rocket launcher.....	73-79	143
Malfunctions of rocket launcher.....	83	158
<b>Marksmanship:</b>		
Antipersonnel .....	47-56	93
Antitank .....	35-46	75
Rocket launcher .....	84-88	161
<b>Nomenclature:</b>		
Rifle grenades .....	29	55
Rocket launcher .....	66-67	123
<b>Operation:</b>		
Hand grenades .....	5	17
Rifle grenades .....	32	72
Rocket launcher .....	80	153

	<i>Paragraph</i>	<i>Page</i>
Police of range.....	22	45
Positions:		
Antipersonnel rifle grenade.....	53	108
Antitank rifle grenade.....	40	80
Hand grenade .....	6	19
Rocket launcher .....	86	161
Practice course:		
Hand training grenades.....	7-11	30
Live grenade .....	13	35
Pyrotechnic signals .....	29	55
Ranges:		
Antipersonnel rifle grenade.....	55	112
Antitank rifle grenade.....	46	88
Range estimation .....	41	82
Rocket:		
AT, HE, 2.36-inch, M6A1.....	68	134
AT, practice, M7A1.....	69	139
Launcher M1A1 .....	64	122
Launcher, M9 .....	64	122
Rocket carrying bag.....	71	142
Safety precautions:		
Hand grenades .....	17-24	42
Rifle grenades .....	57, 58, 79	115, 116, 151
Rocket launcher .....	87	173
Sighting and aiming:		
Rifle grenades .....	34, 37-39	73, 76
Rocket launcher .....	86	161
Sling marking .....	49	94
Speed estimation .....	86	161
Targets:		
Moving .....	43	85
Moving, rocket.....	87	173
Stationary, rocket .....	87	173
Vertical .....	11, 56	33, 115
Tactical employment of rocket launcher.....	89-92	180
Throwing technique, hand grenades.....	5, 6	17, 19
Transporting launcher and ammunition.....	93	185







